

You Can Control Garden Insects 2020



Table of Contents

| | |
|---|----|
| Insect Infestations | 1 |
| Insect Reproduction, Growth and Development | 1 |
| Soil Insects..... | 2 |
| Seed Corn Maggot | 2 |
| Onion Maggot..... | 3 |
| Cabbage Maggot..... | 3 |
| Wireworm..... | 3 |
| White Grub | 3 |
| Potato Tuberworm..... | 3 |
| Early-Season Insect Pests..... | 4 |
| Cutworm | 4 |
| Thrips..... | 4 |
| Flea Beetle | 4 |
| Aphids..... | 4 |
| Lygus Bugs | 5 |
| Insect Pests Infesting Plant Foliage, Pods and Fruits | 5 |
| Mexican Bean Beetle | 5 |
| Stink Bug | 5 |
| Whitefly..... | 5 |
| Hornworms (Tobacco and Tomato)..... | 6 |
| Leafminer..... | 6 |
| Squash Vine Borer | 6 |
| Stalk Borer | 6 |
| Blister Beetle..... | 7 |
| Harlequin Bug..... | 7 |
| Squash Bug | 7 |
| Colorado Potato Beetle | 7 |
| Leafhopper..... | 8 |
| European Corn Borer..... | 8 |
| Fall Armyworm..... | 8 |
| Corn Earworm or Tomato Fruitworm..... | 8 |
| Cowpea Curculio | 9 |
| Cucumber Beetles — Spotted Cucumber Beetle | 9 |
| Cucumber Beetles — Striped Cucumber Beetle..... | 9 |
| Cabbage Looper..... | 9 |
| Diamondback Moth Caterpillar | 10 |

| | |
|--|----|
| Imported Cabbageworm..... | 10 |
| Spider Mites..... | 10 |
| Pickleworm..... | 10 |
| Nonchemical Control of Insects..... | 10 |
| Garden Site Selection..... | 11 |
| Soil Preparation..... | 11 |
| Vigorous Plants..... | 11 |
| Plant Early..... | 11 |
| Diversified Planting..... | 11 |
| Do Not Plant Seed Too Deep..... | 11 |
| Use Physical Barriers..... | 11 |
| Companion Planting..... | 11 |
| Water the Garden..... | 12 |
| Harvest Vegetables..... | 12 |
| Weeds in or Around the Garden Area..... | 12 |
| Use Bacillus thuringiensis..... | 12 |
| Handpicking Some Insects..... | 12 |
| Cut Out the Squash Vine Borer..... | 12 |
| Solarization..... | 12 |
| Repelling Insect Vectors in Tomatoes and Cucurbits..... | 12 |
| Crop Rotation..... | 12 |
| Resistant Varieties..... | 12 |
| Proper Plant Spacing..... | 12 |
| Clean up All Plants..... | 13 |
| Heat..... | 13 |
| Insect Predators, Parasitoids and Disease-Causing Organisms..... | 13 |
| Predators..... | 13 |
| Lady Beetle..... | 13 |
| Ground Beetle..... | 13 |
| Lacewing..... | 13 |
| Praying Mantid..... | 14 |
| Damsel Bug..... | 14 |
| Spider..... | 14 |
| Parasitoids..... | 14 |
| Diseases..... | 14 |
| Chemical Control Insecticide Precautions..... | 15 |
| The Insecticide Label..... | 15 |
| Common Insecticides..... | 15 |
| Chemical Control of Insects..... | 16 |

| | |
|--|----|
| Dusts | 16 |
| Sprays | 16 |
| The Compressed Air Sprayer | 17 |
| Applying an Insecticide to Plants | 17 |
| Spraying | 17 |
| Using Insecticides Properly to Prevent Pollution | 18 |
| Mixing a Garden Spray | 18 |
| Applying a Garden Spray..... | 18 |
| Application Rate of Insecticides for Home Gardens..... | 18 |
| Row Applications..... | 18 |
| Safe Handling of Insecticides | 19 |
| Fire Ants..... | 19 |
| Slugs and Snails | 20 |
| Preplant Insecticides for Wireworms, Fire Ants and Other Soil Insects..... | 20 |
| Organic Pest Management | 20 |
| Home Vegetable Garden Insect Control | 21 |
| Ways to Minimize Pesticide Use in Gardens | 41 |
| Prevent Pest Problems | 41 |
| Inspect Regularly | 41 |
| Use Alternative Control Methods | 41 |
| Pictorial Key of Common Adult Insects on Vegetables | 42 |
| Pictorial Key of Common Immature Insect Pests on Vegetables | 44 |

Helpful website ipm.ncsu.edu/AG295/html/index.html

Insect and Related Pests of Vegetables

K. Sorenson and J. Baker [ed.]

Prepared by Cathy Cameron Carter and K. Sorenson with collaboration by D. Stephan

North Carolina Cooperative Extension Service

We thank the following institutions for providing the black and white images that may have been used in this publication:

North Carolina State University Cooperative Extension Service

University of Maine Cooperative Extension Service

Ohio State University Extension Service

University of Nebraska Cooperative Extension Service

Natural Resources Canada

USDA, ARS

Cover photo of spotted cucumber beetle by Frank A. Hale.

You Can Control Garden Insects

*Karen M. Vail, Professor; Frank A. Hale, Professor; Jennifer Chandler, Research Specialist III
Department of Entomology and Plant Pathology*

Insect Infestations

Insect infestations reduce yields and lower the quality of harvested garden vegetables. Three to seven generations of many insect pests attack garden vegetables during the growing season. All plant parts may be injured by insects. Some insects bore into roots, seeds or stems. Many suck large quantities of plant sap. Others destroy crops by chewing on the succulent foliage, stems or fruits. Plant diseases are carried by certain insects.

Safe, effective and economical control measures can minimize the loss from insects. Control can be maintained all season by a combination of cultural practices, mechanical control, biological control and chemical applications. To maintain control, follow these practices, as they apply to the vegetables in your garden:

- Anticipate insect pest problems.
- Remove other vegetation and debris that harbor insects from vegetable garden beds.
- Turn under spent plants when the vegetables have been harvested.
- Inspect plants regularly for insect infestations and spray insecticides when needed.
- Apply insecticidal sprays when the young, most vulnerable stages of insect pests are beginning to hatch or emerge.
- Observe use restrictions and avoid applying insecticide on garden vegetables within the minimum number of days between last application and harvest (pre-harvest interval).
- Select insecticides that take a short time to control insects during the harvest period that have a short pre-harvest interval.

Insect Reproduction, Growth and Development

How Insects Grow

Most insects develop from an egg and, upon hatching, have a form different from that of the adult. The series of form changes as an insect develops from egg to adult is called **metamorphosis**. The young insect is covered with a more or less firm skin called the **exoskeleton**. As the insect feeds, it grows inside this skin, but it cannot increase in volume because it is restricted by its exoskeleton. A new elastic exoskeleton then forms under the old rigid exoskeleton. The old exoskeleton splits along the back and the insect crawls out of its old skin and expands to its new size. After exposure to air for a short time, the new exoskeleton becomes hardened and the insect is ready to resume activity and grow some more. The process of shedding the old skin is called **molting**. Molting occurs several times over varying periods of time until the final stage is reached.

With each molt insects change their form to varying degrees, depending on the kind of metamorphosis that insects may have. Most vegetable garden insect pests have either gradual (Figure 1) or complete metamorphosis (Figure 2). Examples of gradual or incomplete metamorphosis, in which the very young resemble the adults, include plant bugs, grasshoppers, stink bugs, squash bugs, aphids and leafhoppers. Examples of pests with complete metamorphosis are Mexican bean beetles, cabbage loopers, hornworms, flies, June beetles, cutworms and armyworms.

Gradual metamorphosis (Figure 1). Generally these young insects resemble the adults. In proportion to the rest of the body, the legs and head become relatively smaller in each instar. This is because the head and legs do not grow as fast as the rest of the body. In insects that are winged, there is also a gradual development of the wings with each molt. There are no more molts after the fully developed, winged, adult emerges. Not all of these insects develop wings. The young are called nymphs. Nymphs and adults inhabit the same places and eat the same kind of food.

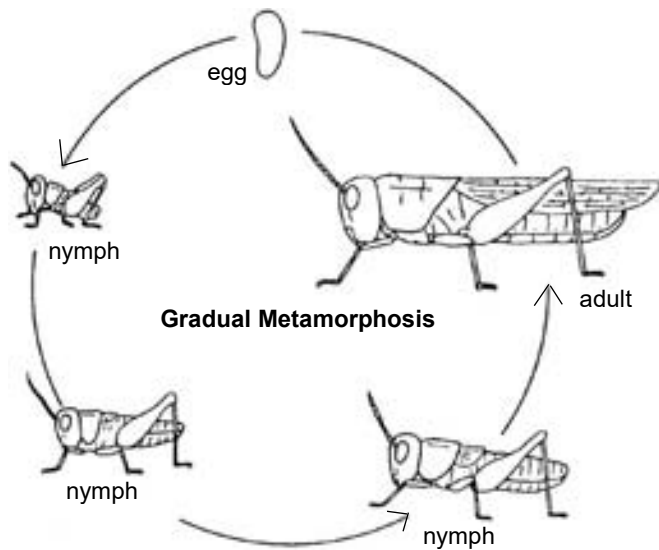

Figure 1

Complete metamorphosis (Figure 2). All four stages of development — egg, larva, pupa and adult — are present. All increases in size occur during the larval stage. Some people erroneously think that small flies will grow to be big flies. At the end of the larval stage, the insect transforms into a pupa, which does not feed or move about. It is sometimes called a resting stage, but inside the pupal skin drastic changes are taking place. More alteration of form is going on during the pupal stage than during any other period of the insect’s development. Out of the pupa emerges the fully formed adult, complete with wings. No further molts occur. The larvae and adults of these insects may live in different habitats, eat different food, have different kinds of mouthparts and have many other differences. The larval stage of some orders of insects are called maggots, grubs or caterpillars.

Soil Insects

Many garden insect pests live in the soil during one or more stages of their life cycle. These insects are adapted to feeding in or on the planted seeds, roots or lower stems of plants.

The length of time the individual insect lives in the soil varies from two to three weeks for some flies, to three years for some wireworm species.

These insects may either occur as large numbers of newly hatched larvae or as partially grown overwintered larvae with a ravenous appetite at the time you plant your garden. The plants can be severely damaged or even killed in just a few days following planting.

Anticipate problems with soil insects. Inspect the plant bed soil thoroughly as you cultivate the bed.

Seed Corn Maggot



Description: Small, white maggots without legs or a distinct head, about 1/3 inch long, that feed externally and internally on roots and seeds.

Damage: Death of small plants may result from maggots feeding on roots.

What to do: Avoid planting spring turnips and radishes in soil that is high in partially decomposed organic matter. Do not plant in wet soil.

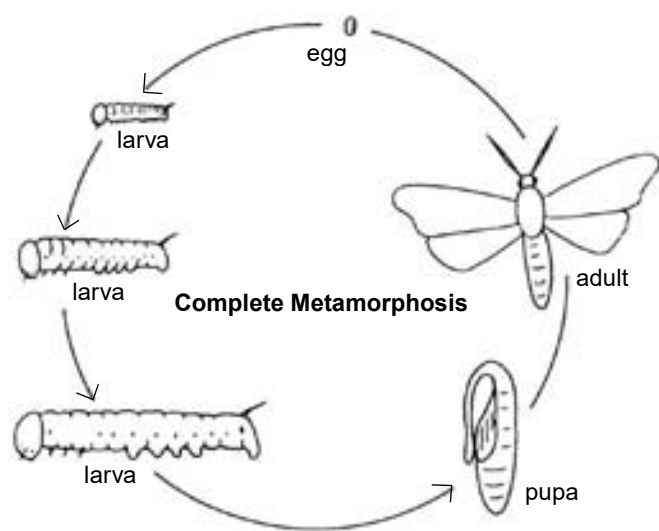

Figure 2

Onion Maggot



Description: Small white maggots without legs or distinct head, about 1/3 inch long, that bore through underground stems and bulbs.

Damage: Thinning of stands often results from plant death caused by the maggots tunneling in small bulbs. Even if they are not totally destroyed in the garden, damaged bulbs will rot in storage.

What to do: Avoid planting onions in an area high in partially decomposed organic matter. Cull onions should be removed from the garden after harvest.

Cabbage Maggot



Description: Yellowish white; legless larva; blunt at the rear end and pointed at the front; about 1/4 to 1/3 inch long. The adult fly lays eggs in the soil around the base of the plant, and the eggs hatch into maggots that burrow down to adjacent roots.

Damage: The maggots are destructive in seed beds and in young transplants. They feed on the roots and stems just below the surface; seedlings wilt, turn yellow and die. Infested cabbage rarely produces a head. Maggots are also reported to introduce a fungus causing blackleg and to spread bacterial soft rot.

What to do: Protect seedlings from egg-laying adults by covering with floating row cover or netting to exclude the fly. Don't plant in cold, damp soil. In the spring, wait until the soil warms up and is sufficiently dry. Add any organic matter to the soil in the fall to reduce soil's attractiveness to egg-laying spring cabbage maggot flies.

Wireworm

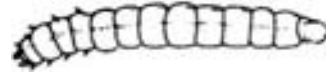

Description: Shiny, slick, reddish-brown, tough, 6-legged worms up to 1 1/2 inches long.

Damage: The wireworm tunnels through tubers, making deep, more or less cylindrical burrows.

What to do: Avoid planting potatoes in an area that has been in sod within the last year.

White Grub



Description: Several species. White or light yellow; hard brown heads; curved; 1/2 inch to 1 1/2 inches long when full grown. White grubs are the larvae of some types of scarab beetles that live in soil. May and June beetle white grubs can be pests of tuber and root crops such as Irish potatoes and sweet potatoes. They require two years to mature. Adult lays eggs in grassy areas so avoid planting potatoes or root crops in an area that has been in sod for the past year or two.

Potato Tuberworm



Description: White caterpillars up to 3/4 inch long with a pinkish or greenish tinge and brown at both ends.

Damage: Larvae burrow into stems and petioles and mine the leaves of plants. The tubers of potatoes in the field and in storage are riddled with slender, dirty-looking, silk-lined burrows.

What to do: Keep potatoes well cultivated and deeply buried in hills during growth. Infested vines should be removed before digging to avoid larval movement to tubers.

Early-Season Insect Pests

Early-season insect pests infest and damage seedling plants early in the growing season. They feed on leaves and stems of young seedling plants.

Cutworm



Description: Plump, smooth-skinned, greasy-looking caterpillars up to 1 inch long often found curled up at base of plants.

Damage: Young transplants may be cut down at ground level, or branches may be removed from larger plants. Some damage to small tomato fruit may occur on older plants.

What to do: Physical barriers, such as aluminum foil wrapped around a 4-inch length of stem between leaves and roots, may be used to protect newly set transplants. Baits, sprays or recommended insecticides may be needed. Avoid planting tomatoes in soil recently in grass or sod.

Thrips



Description: Adult — extremely small (1/25 inch long), yellow or brown winged insects; very active. Nymph — similar to adult but smaller and wingless. Thrips often feed on weeds in and around the garden.

Damage: Adults and larvae suck plant juices and cause whitish blotches. Tips of leaves may become distorted and die. Entire plants may wither and fall over with severe infestations.

What to do: Set onions should not be grown near seed onions. Weeds in and around the garden should be removed to reduce buildup of thrips. Beginning when thrips are numerous enough to cause scarring of leaves, two or three applications of a recommended insecticide should be made at weekly intervals or as directed by label. Certain varieties of sweet Spanish onions possess considerable resistance to injury.

Flea Beetle



Description: Adult — many species; very small, black or striped shiny beetles 1/16 to 1/8 inch long that jump readily when disturbed. Adults overwinter under leaves, grass and trash in and around the garden.

Damage: Adults chew tiny holes in the leaves.

What to do: Removal of weed hosts will reduce flea beetle populations. When extremely heavy populations are observed on weeds surrounding the garden, insecticide treatment of garden margins may prevent entry by the pest. When beetles and damage are seen on eggplant or beets, apply a recommended insecticide before serious damage results.

Aphids

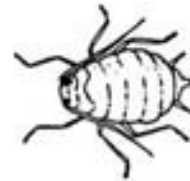

Description: Adult and nymphs — small, soft-bodied, yellow, pale green or powdery grey; about 1/8 inch long with two “tail pipe” looking cornicles. Usually occur in colonies or clusters on the undersides of leaves and in broccoli heads.

Damage: Adults and nymphs suck plant juices, leaves thicken, wrinkle, and turn yellow or brown; small plants may be severely weakened. Broccoli is very sensitive to aphids, which are difficult to remove from the heads in preparation for eating.

What to do: Observe small plants closely after rapid growth begins in the spring. Wash the aphids from the plants daily with a forceful stream of water until the population is no longer a problem or apply a recommended insecticide when colonies are found in the absence of enemies such as lady beetles.

Lygus Bugs

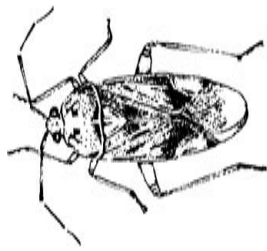

Description: Several related species including tarnished plant bug are included in this group. They are flat, oval, mottled with white, yellow and black splotches that give it a tarnished appearance; 1/4 inch long. When disturbed, these active insects fly or move to opposite side of stems; they are seldom seen.

Damage: Adults and nymphs pierce and suck juices from the pods, stems and blossoms. This feeding causes blossoms and young pods to drop from the plants. Feeding on the older pods causes the pods and seed to be pitted and undesirable for food. The pods may also be deformed.

What to do: Dust or spray with an insecticide labeled for the specific crop. Clean up and destroy weeds and trash in the fall to prevent overwintering.

Insect Pests Infesting Plant Foliage, Pods and Fruits. These Pests Continue Feeding on Garden Plants Throughout the Season.

Mexican Bean Beetle



Description: Adult — coppery-brown rounded beetles; about 1/4 inch long, with 16 black spots on the back. Adult spends the winter in rubbish and weeds. Larva — yellowish, soft-bodied and fuzzy. Clusters of yellow eggs are laid under the leaves.

Damage: Leaves appear lacy from adults and larvae chewing on the undersides.

What to do: Apply a recommended insecticide or hand pick adults and larva and crush the eggs. Clean up plant debris after harvest to reduce

overwintering adults. Plant early and pick mature pods promptly. For more information, see <https://extension.tennessee.edu/publications/Documents/SP341-Z.pdf>

Stink Bug



Description: Adult is shield-shaped, flat, bright green or brown, 5/8 inch long with wings and a narrow head; bad-smelling when crushed. The nymph resembles adult in shape, but is somewhat more rounded than shield-shaped, wingless, and green, orange and black. Adults overwinter in weeds.

Damage: Adults and nymphs suck juices and cause pods to fall and cause distortion of seeds. Brown spots form on the pods from the feeding.

What to do: Apply a recommended insecticide; keep the weeds down both in and around the garden.

Whitefly

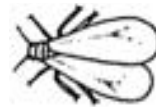

Description: Adults — very small sucking insects with two pairs of broadly rounded wings covered with a snow white waxy powder. They look like tiny moths and fly out in a cloud when disturbed. Larvae are very small flat, scale-like insects, difficult to see. All stages feed on the undersides of leaves and excrete honeydew.

Damage: The flies suck plant juices, causing leaf discoloration, leaf drop and stunting of plants. A sooty mold grows on the honeydew, causing a black unsightly appearance on the leaves.

What to do: Use a recommended insecticide.

Hornworms (Tobacco and Tomato)

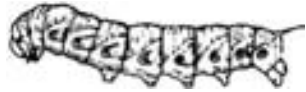

Description: Large, green caterpillars with a white diagonal stripe on abdominal segments of tobacco hornworm and V-shaped white marking on tomato hornworm; up to 3 or 4 inches long with a slender horn projecting from near the rear end.

Damage: Hornworms feeds on leaves, consuming large amount of foliage. Leaf loss may result in stunting and fruit scald.

What to do: Handpicking and destruction are often easily accomplished because of size. If large numbers of hornworms or plants are involved, use a recommended insecticide.

Leafminer

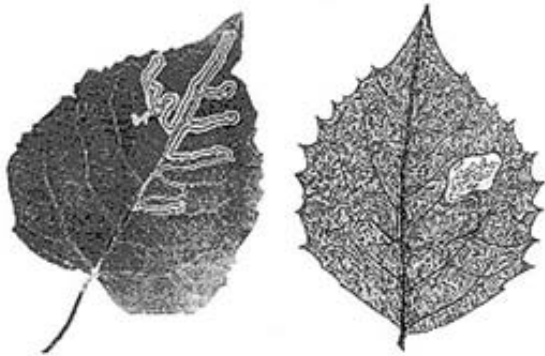

Description: Winding white trails or broad white spots appear on leaves, made by small white or yellow legless maggots feeding between upper and lower surfaces of the leaf.

Damage: The leaves may be weakened, and the mines or tunnels may serve as points where disease and decay may start.

What to do: Handpick infested leaves, if practical, before the larvae pupate and begin another generation, or use a recommended insecticide when large numbers of mines are found.

Squash Vine Borer

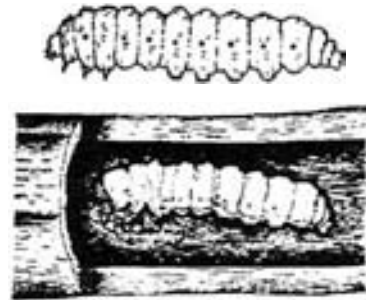

Description: Thick, white, wrinkled, brown-headed caterpillars, up to 1 inch long. Produces yellowish, sawdust-like excrement from holes in the vines.

Damage: Infested vines are often completely girdled and usually become rotten and die beyond the point of attack. Late in the season, some tunneling in and damage to fruit may occur.

What to do: Plant as early as the weather will allow. With few infested plants, stems can be split and larvae removed. A spade-full of moist soil should be placed over damaged stems to encourage new root growth. Apply a recommended insecticide weekly or as directed by label during the fruiting period. For more information, see

<https://extension.tennessee.edu/publications/Documents/SP503-A.pdf>

Stalk Borer



Description: Slender, up to 1 ½ inches long. Young borer: creamy white, dark purple band around the body, several brown or purple stripes running lengthwise down the body. Full-grown borer: creamy white to light purple without band and stripes.

Damage: Eats tunnel in stem, causing plant to wither and die. Tunnel usually has opening up to 1/4 inch in diameter at its lower end. Attacks pepper, corn, potato and rhubarb.

Distribution: East of Rocky Mountains.

What to do: Remove and destroy weeds; the insect breeds in weeds, especially dock and ragweed. Plant may be saved by puncturing the insect. To locate the borer, split the stems lengthwise above opening to tunnel. Bind split stem and keep plant watered.

Blister Beetle



Description: Soft, slender beetles with long legs; 1 ½ - 1 ¾ inches long; either black, grayish or black with narrow gray or yellow stripes on margins of the wing covers.

Damage: Leaf removal from large members of beetles feeding on the foliage may cause fruit injury by sun (sun scald).

What to do: Apply a recommended insecticide.

Harlequin Bug



Description: Adult — orange/red and black, shiny, flat, shield-shaped; about 3/8 inch long. Nymph — orange/red and black, oval, no wings. Eggs — white with black rings, barrel-shaped; laid in double rows under the leaves. Adults overwinter around trash and old plants in and around the garden. This bug has a disagreeable odor.

Damage: Sucking adults and nymphs cause yellow splotches; leaves wilt, turn brown and die.

What to do: Handpick bugs and crush their eggs as they appear; if necessary, apply a recommended insecticide; keep weeds and trash down in and around the garden to reduce overwintering adults.

Squash Bug



Description: Adult — the winged adult is dingy gray-black and nearly an inch long with a narrow head. Adults and nymphs have a very disagreeable odor when crushed. Nymph resembles adult in general shape. Nymphs have black antennae and legs and gray bodies. Later they become darker, the head and legs turning black and the body light to dark gray.

Damage: Adults and nymphs suck plant juices. Young plants can be severely weakened or killed. Older plants often have one or more runners damaged. Leaves on damaged runners wilt and become crisp and dark brown.

What to do: If only a few vines are involved, the easiest control method is hand collection of eggs and bugs. The eggs are 1/6 inch long, elliptical, yellowish- brown to bronze, and usually in clusters on the underside of leaves. Garden sanitation reduces overwintering populations. Apply a recommended insecticide to control the young nymphs, because the adults are very difficult to control with insecticides.

Colorado Potato Beetle



Description: Adult — yellow and black striped, hard-shelled beetle about 3/8 inch long. Larva — brick-red, humpbacked, soft-bodied larva with rows of black spots along each side of the body. Eggs — orange, elongated eggs laid on the leaves.

Damage: Adults and larvae eat holes in leaves, especially damaging to small plants.

What to do: The Colorado potato beetle is notorious for its ability to develop resistance to insecticides. Applying a recommended insecticide as soon as adult beetles are observed may provide control. If the initial application is made before

egg-laying, repeat treatments may be unnecessary. Adults, larvae and the eggs may be hand-picked from plants and destroyed.

Leafhopper

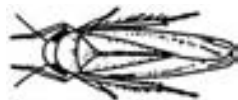

Description: Small, very active, greenish, slender, wedge-shaped jumping insects up to 1/8 inch long.

Damage: Leafhoppers suck sap from undersides of leaves causing tiny chlorotic stippling-like spots. The potato leafhopper causes tips of leaves to turn brown, often followed by the browning and curling of the leaf margin.

What to do: Apply a recommended insecticide.

European Corn Borer

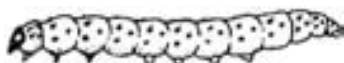

Description: Flesh-colored; rows of small, round, dark-brown spots; dark-brown head; up to 1 inch long. Overwinters as a caterpillar in the stalk.

Damage: Larvae bore into the stems of plants and cause breakage. Heaviest damage occurs late in the season. In addition, larvae may enter peppers by boring under the cap (where the stem attaches to the fruit). Larvae feed in corn tassels and young leaves in the whorl, soon moving to tunnel in the stalks and the ear; may enter the ear at the base, side or tip. Broken tassels and stalks, shredded leaves, sawdust castings outside small holes in the stalk and ear are signs of the borer.

What to do: Plant as early as the weather permits; apply a recommended insecticide when larvae are first found. Apply a recommended insecticide when the corn borers are first seen in the whorl and before they enter the stalk and ear. Remove old plants after harvest to reduce borer numbers.

Fall Armyworm

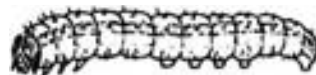

Description: Light green to black, striped; black head with inverted white Y on the front of the head; about 1 ½ inches long. Feeds at night.

Damage: Attacks the young emerging corn leaves in the whorl and also a pest of the ear. Fall armyworms will chew through the husks to attack the kernels, whereas corn earworms enter the tip. Often several fall armyworms are found in an ear.

What to do: Apply a recommended insecticide. Plant early.

Corn Earworm or Tomato Fruitworm



Description: Fully grown larvae are up to 1 3/4 inches long; variable in color from light green to pink to brown to nearly black, marked with alternating light to dark stripes running lengthwise on the body. The head is light orange, brown or green, and the legs are dark or nearly black. The skin of the larvae is coarse with short black hairs (like on a two-day old beard).

Damage: Earworms chew buds and leaves in the corn whorl, resulting in large ragged holes as the leaves unfold and may cause plants to be stunted; they later feed on the silk and the kernels from the tip of the ear downward; seldom more than one corn earworm per ear. Chewed-off silk prevents pollination; various mold fungi are introduced into the ear. Holes are eaten in tomatoes, causing them to rot.

What to do: Plant as early as the weather permits; apply a recommended insecticide when larvae are first noticed, or when damage is first observed.

Cowpea Curculio



Description: Adult — black, hump-backed, hard-shelled beetle, nearly 1/4 inch long, with a slender snout and prominent round punctures (dimples) on the back. Larva — whitish, legless grub inside the pods.

Damage: Adults cause black wart-like stings on surface of pods by feeding and egg-laying activities. Larvae develop from eggs deposited inside pods. Larvae feed on one or more peas during their course of development.

What to do: Where feasible, remove broomsedge and bluestem from garden edge to reduce overwintering sites.

Cucumber Beetles — Spotted Cucumber Beetle



Description: Adult — greenish-yellow, 12 black spots on wings, black heads, slender, about 1/4 inch long. Adult overwinters at the base of plants, which are not entirely killed down by the frost.

Damage: The beetles eat holes in the leaves and flowers and carry bacterial wilt. They often attack young seedlings even before they emerge. Larvae tunnel roots and stems of beans, corn and grasses.

What to do: Protect young plants by cone-shaped netting or screen protectors until runners develop; apply a recommended insecticide; clean up weeds to reduce overwintering adults.

Cucumber Beetles — Striped Cucumber Beetle



Description: Adult — pale yellow to orange, three black stripes on wings, black heads, about 1/4 inch long. Larvae — white, brownish at the ends; slender.

Damage: Adults feed on the leaves, stems, and fruit and transmit bacterial wilt. Larvae sometimes feed on underground stems and roots of cucumbers and related plants.

What to do: Cover seedlings with netting or cone-shaped screens until runners form; or apply a recommended insecticide.

Cabbage Looper



Description: Pale green, smooth-skinned worms up to 1 1/4 inches long, which make a loop in the middle portion of the body as they move along the plant. Brown pupae are attached to one side of a plant leaf during the growing season.

Damage: Large holes are eaten in leaves. So much leaf tissue may be consumed that plant growth is interfered with. Larvae may be present in the heads and go unnoticed until cooking.

What to do: It is very important to control these larvae while small, as the larger ones are quite difficult to control. Conventional chemical insecticides often fail. Applications of *Bacillus thuringiensis* (Dipel or Thuricide) are usually effective in keeping populations under control.

Diamondback Moth Caterpillar



Description: Greenish-yellow with black hairs; slightly pointed at both ends; wiggles rapidly when disturbed and hangs from a silk thread; about 1/3 inch long. Overwinters as a pupa in the leaves of the host plant such as cabbage, broccoli and other cole crops.

Damage: Larvae chew holes in all parts of the plant, but prefer areas around the bud. Larvae may be present in the heads and go unnoticed until cooking.

What to do: Apply a recommended insecticide. Clean up old plants after harvest to remove pupae.

Imported Cabbageworm



Description: Velvety green with a narrow orange stripe down the middle of the back and a broken yellowish stripe along each side; about 1 1/4 inches long. Overwinters as pupae in the leaves of the host plant or other objects nearby.

Damage: The larvae chew holes in the leaves and are more likely to feed near the center of the plant. Larvae may be present in the head and go unnoticed until cooking.

What to do: Apply a recommended insecticide. Clean up old plants after harvest to remove pupae.

Spider Mites



Description: Tiny (barely visible) red, orange, yellow or green mites that suck juice from the undersides of leaves. Fine webs on the leaves.

Damage: Yellow spots on leaves; leaves turn yellowish brown and drop; plants are stunted.

What to do: Frequent high pressure syringing

with water will tend to reduce populations; wait for natural predators to reduce the mites if the population doesn't get too high or apply a recommended miticide.

Pickleworm



Description: Yellowish-white caterpillar with dark spots when young; old larvae are greenish or coppery; up to 3/4 inch long. Overwinters in south Florida and spreads northward each year.

Damage: Burrow into buds, blossoms, vines and fruits. The larvae push out small masses of green, sawdust-like excrement from holes in the fruit, causing rotting and loss of fruit.

What to do: Plant as early as the weather will allow. Apply a recommended insecticide during the fruiting period. For more information, see <https://extension.tennessee.edu/publications/Documents/W206.pdf>.

Nonchemical Control of Insects

Chemical dusts and sprays offer the most consistent, most effective and easiest method of controlling insects. However, they do have disadvantages: they kill both the bad and good insects; chemicals used previously may no longer be effective (the insects are said to be resistant to this chemical or group of chemicals); they are toxic and must be handled and stored carefully; they may leave excessive pesticide residues on the food unless label instructions are carefully followed; and they are often expensive.

There are many excellent cultural, mechanical and biological control methods that can be used for insect control. Most gardeners will find that a combination of nonchemical and chemical methods work best.

Garden Site Selection

Where possible, avoid planting your vegetable garden in ground that was in sod within two to three years. Soil insects are more likely to be numerous in this situation. Digging or plowing the garden as described below will help.

Soil Preparation

Several species of soil insects (wireworms and white grubs) feed on the roots and seeds of garden vegetables. Many of these pests are harbored on weeds or grasses in the garden before vegetables are planted. The garden should be dug or plowed in the fall and again in the spring, at least three weeks before planting. This practice not only eliminates weeds supporting these pests, but also exposes many pests to drying, cold weather and predators. Rotating crops to new locations in the garden also aids in reducing insects.

Vigorous Plants

Healthy plants are better able to tolerate pest damage than weak sickly ones. Use only the plant varieties best suited for your part of Tennessee and use the correct amounts of fertilizer, lime and water. You can obtain a soil test box and submission sheet through your county Extension office or access the UT Soil, Plant and Pest Center for information on how to submit a soil sample at soillab.tennessee.edu/soil-fertility. On this site note that it says, "During COVID, you do not need a soil box. Please fill a sturdy quart plastic bag and write your name in permanent marker."

Plant Early

The number of insects successfully overwintering is actually quite low, but because of their reproductive capacity, large populations develop by late summer. If corn, cucurbits, tomatoes, peppers, eggplant and cole crops are planted as early as weather permits, many of these vegetables will be mature and harvested before heavy insect pressure occurs.

Diversified Planting

Many insects attack plants belonging to a certain species or family and reject unrelated ones. For example, striped cucumber beetles enjoy cucumber, squash and melons (cucurbit

family) and are not a pest of corn or beans. Thus, do not plant all those cucurbits or others of the same group in one place in the garden if you can avoid it. If you have many tomato plants, do not put them all in the same location. Insects that begin to attack a particular vegetable often will spread to similar neighboring plants. You may be able to reduce your losses if you do not put all of one group in the same location. Groups of related vegetables are as follows:

| | |
|-----------------------|---|
| Cole crops | cabbage, cauliflower, collards, brussels sprouts, broccoli |
| Greens | lettuce, endive, mustard, turnips (tops) |
| Root/bulb | sweet potatoes, onion, garlic radishes, turnips, beets, carrots |
| Cucurbit crops | cucumbers, gourds, melons, pumpkin, squash |
| Legumes | beans, peas |

Do Not Plant Seed Too Deep

Seed planted deeper than accompanying directions may often rot before they germinate or crack through the soil.

Use Physical Barriers

Transplants such as tomato, pepper and eggplant can be wrapped with a 4-by-4-inch strip of aluminum foil to prevent cutworm damage and contact with the soil-borne southern blight organisms. Wrap the stem area between the roots and leaves with foil and plant so 2 inches of stem are below the soil and 2 inches are above the soil. Do not allow the soil to touch the uncovered stem above the foil.

Companion Planting

There is little data to prove or disprove the value of companion planting, although this arrangement has been used by many gardeners who claim success. Presumably some herbs and other plants repel specific insect pests and planting these in association with a particular vegetable

gives some protection. A few common plantings are as follows:

- Interplant beans with rosemary to control Mexican bean beetles.
- Interplant tomatoes with basil to repel the tomato hornworm.
- Interplant eggplant with catnip to repel flea beetles.
- Interplant cucumbers with radish or nasturtiums to control cucumber beetles.
- Interplant cabbage with thyme to control imported cabbageworms.

There are many other combinations found in the literature, but remember there is little definite information available on their effectiveness. The latter four listed have been tested in south Georgia with disappointing results.

Water the Garden

Furrow irrigation is ideal. If overhead sprinklers are used, water after the dew dries in the morning or early in the afternoon so the foliage will dry before night. Do not allow foliage to be wet for more than eight to 10 hours.

Harvest Vegetables

The longer a vegetable is in the garden, the longer it is exposed to insect attack. In addition, overripe vegetables are more attractive to certain insect pests and invite an unwanted invasion.

Weeds in or Around the Garden Area

Some insects are first attracted to weeds and will then move into your vegetable garden. In addition, heavy weed stands increase humidity and subsequent insect severity. Constant weed control is essential, because destruction of a heavy weed stand can cause migration of an insect population to the crop. Mulching is a good way to keep the weeds down in the garden, and it has many other benefits as well.

Use *Bacillus thuringiensis*

This biological insecticide contains a toxin of a bacterium that is deadly to cabbageworms (and other caterpillar species), but harmless to humans, pets and beneficial insects. It is available under the trade names of Dipel, Thuricide and others.

Handpicking Some Insects

Destroying insects that are large enough to pick and slow enough to capture and destroying egg masses are often quick methods of insect control. Tomato hornworms are often easily controlled by handpicking. Removing Colorado potato beetles by hand is also successful.

Cut Out the Squash Vine Borer

When the squash vine borer is found tunneling in the base and runners of squash, you can split the stem to find the larva, kill or remove it, and place about a shovel full of damp soil over the wound to encourage new roots.

Solarization

Solar heating of moist soil by means of polyethylene mulching, particularly during the summer months, is effective in reduction of soil-inhabiting pests. Soil should be tilled, fairly moist and covered with clear plastic for optimum control of these pests. For more information, see <https://extension.tennessee.edu/publications/Documents/W363.pdf>.

Repelling Insect Vectors in Tomatoes and Cucurbits

Thrips and aphids spread several diseases and the only protection against the disease is controlling the insect vector(s). Highly reflective surfaces tend to repel most thrips and aphids. Aluminum foil or chrome-colored plastic mulch may aid in repelling these insects.

Crop Rotation

Crops should be rotated to avoid the buildup of pests associated with that crop.

Resistant Varieties

Resistant varieties are either tolerant of pests, not preferred by pests or negatively affect pests. Resistant varieties should be used whenever possible.

Proper Plant Spacing

Proper plant spacing allows the plant canopy to

shade the ground, thereby preventing weeds from growing and decreasing the rate at which the soil dries. Plants spaced too far apart will allow weeds to grow and those spaced too closely could be stressed due to competition for light, nutrients and water.

Clean Up All Plants

Many insects will mature or overwinter in plants they fed on. Removing debris or end-of-season plowing will reduce pest populations.

Heat

Where allowed, burning off old crop residue may reduce harboring pests.

Insect Predators, Parasitoids and Disease-Causing Organisms

Outbreaks of insect pests in home gardens often result because the pests have no natural enemies or their natural enemies are lacking. The natural enemies of garden insect pests that play the greatest role in keeping pests in check are predators, parasitoids and disease-causing organisms. These natural enemies are found on a wide variety of crops — they go where the pest is. It is important that you be able to recognize these beneficial organisms, and not mistake them for destructive pests needing control.

Predators

The most common predators in gardens are various beneficial insects and spiders. Predators actively seek, kill and consume a large part of the pest insect. Common predators are lady beetles, ground beetles, lacewings, praying mantids, damsel bugs and spiders.

Several mail order businesses advertise predators for sale, particularly lady beetles and praying mantids. Release of these beneficials in a garden rarely leads to pest suppression, because the beneficials quickly disperse in search of additional prey. In addition, there are generally a number of these beneficials already in the garden. Therefore, it is more important that you learn to distinguish the beneficial insects from the destructive ones already in your garden than to buy or import insects.

Lady Beetle

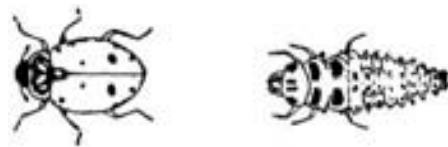

Lady beetle adults are oval-shaped insects that vary in color but usually have black or orange-red spots on their wing covers. Lady beetle larvae are spindle or carrot-shaped with conspicuous warty or spiny backs. They usually are black, blue and orange with thick, stubby legs. Both the lady beetle adults and larvae feed on small, soft-bodied insects and insect eggs. Lady beetle eggs are yellow to orange and laid in a cluster of five to 20 eggs. They are found standing on end in contact with one another. All stages of lady beetle development are usually found on the foliage of plants.

Ground Beetle



Ground beetle adults are flat, black or brown, long-legged and swift-running insects. Sometimes the colors are brilliant metallic greens, blues or purples, occasionally spotted with iridescent dots or pits of gold. The adults range in length from ½ to 1 ½ inches. Ground beetle larvae are dark-colored, slender, a little flat and slightly tapering to the tail, which terminates in two bristly, hair-like or spine-like structures. Both the adults and larvae feed on small, soft-bodied insects, eggs and worms. Ground beetle adults and larvae are generally found on the soil, acting as ground level predators.

Lacewing



Lacewing adults are insects that have many veins in their wings, giving them a net-like appearance. The wings are held roof-like over the back. The adults are green or brown, and some have characteristic golden-colored eyes. Lacewing larvae are about ½ inch long, spindle-shaped insects with long, sharply pointed mandibles that protrude out from the front of the head. These larvae are tan and white with a warty or spiny appearance. Larvae eat small, soft-bodied insects, eggs and worms. The eggs of the lacewings are small, green to whitish and are always laid at the end of a slender, thread-like stalk.

Praying Mantid



Praying mantids are green or brown with long bodies and papery wings (if they are present). These medium to large insects are readily recognized by the enlarged front legs that are used for grasping its prey.

Eggs are laid in a mass, arranged in a definite pattern of rows and glued together. The egg mass is rather commonly observed glued to branches of trees, fence posts or other objects. The winter is spent in the egg stage. Only one annual generation of this insect has been observed. The praying mantid has often been given too much credit as a predator, perhaps because of its size and menacing looks. Praying mantids are basically lazy and generally wait for the prey to come to them. In addition, they will feed on other beneficial insects.

Damsel Bug

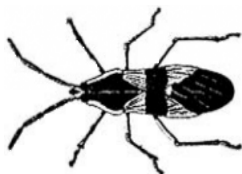

Damsel bug adults are long, slender, cigar-shaped insects. They are tan to brown and about

½ inch long. The wings are light smoky-colored. The front legs are thick and made for grasping and holding their prey. Damsel bug nymphs resemble the adults except they have no wings and appear very fragile. Both the adults and nymphs feed on small, soft-bodied insects, worms and eggs.

Spider



Spiders are not insects, but this group of arthropods is very important as predators of insects in the garden. Many types of spiders are found in the garden and vary greatly in size and color. They will prey on almost any insect that comes within their range.

Parasitoids

Some insects will feed inside the bodies of other insects, eventually killing them. These insects are called parasitoids. The mature larvae exit the back of the hornworm body and immediately start spinning their white silk cocoons in which they pupate.

One of the most common parasitoids found in home gardens is a braconid wasp, which lays its eggs in the body of tomato hornworms. The eggs of this parasitoid hatch into larvae that riddle the internal organs of the hornworm during development. These are often mistaken for hornworm eggs by the gardener and subsequently destroyed. However, effort should be made to preserve these pupae, since the adult parasitoids will emerge from them to continue their beneficial activities.

Diseases

Microorganisms pathogenic to insects occur commonly among protozoa, bacteria, fungi and viruses. The most common natural diseases in garden insect pests are caused by the latter two

groups of microorganisms. However, they are usually effective in reducing pest numbers only after pests reach high population levels. Such pest levels are too destructive to vegetables to await the spread of the disease.

Because of the increased interest and research in diseases for controlling pest insects, it is expected that more of these biological control agents will be made available in the future.

Chemical Control Insecticide Precautions

Insecticides used incorrectly can be injurious to you and your garden vegetables. The best insurance against hazards is the careful observance of the insecticide label directions and precautions. Before purchasing an insecticide, and again before using it, you should read the label and make sure you are able to follow all directions and precautions.

Store all insecticides behind locked doors (or at least out of reach of children) in original containers with the labels intact. The storage area should keep the insecticides from freezing temperatures, but do not sacrifice safety by storing near food, clothing or medicines.

Apply insecticides selectively and carefully. Do not apply an insecticide when there is danger of drift to other areas. Generally, the wind is most calm in early morning or late evening hours. To protect pollinators, cover any nearly flowering plants with a tarp while spraying. It can be removed soon after. Avoid prolonged inhalation of an insecticidal spray or dust. When applying an insecticide, you should wear at least a long-sleeved shirt, long pants, shoes and socks.

After handling an insecticide, do not eat, drink or smoke until you have washed with soap and water. If an insecticide is swallowed or gets in the eyes, follow the first aid treatment given on the label and get prompt medical attention. If an insecticide is spilled on your skin or clothing, remove clothing immediately and wash skin thoroughly.

The insecticides recommended for home garden use are among the safest available, but should be treated as potentially dangerous poisons.

The best way to dispose of an insecticide is to use it in accordance with label directions. When a container is empty, it should be rinsed three times with water, and the rinse water should be added to the spray tank. Empty containers of most homeowner insecticides can be disposed of with household garbage. Wrap in several layers of paper and tie. Follow the directions on the label.

Insecticides vary in their toxicity to humans and domestic animals. The toxicity is measured in milligrams of the insecticide per kilogram of body weight of the test animal that produces a 50 percent mortality rate in tests. Since a milligram is 1/1000 of a gram and a kilogram is 1000 grams or 2.2 pounds, the toxicity is actually expressed in parts per million. As the toxicity rating is based on the amount of the active ingredient of an insecticide in a mixture, it follows that the diluted spray mixture is a much smaller toxic hazard than a concentrate.

The Insecticide Label

Always read the label carefully on the insecticide container. It will tell you the active ingredient as well as the maximum amount or concentration that can be used safely. Pay particular attention to warning statements and precautions. Always observe recommended intervals between the last application and harvest to avoid harmful residues on the produce. Apply an insecticide product only to those crops that are listed on the label.

- **Highly toxic insecticide labels**
have "DANGER POISON"
signal words SKULL &
CROSSBONES
- **Moderately toxic insecticides**
have Warning signal word
- **Slightly toxic insecticides**
have Caution signal word

Common Insecticides

Carbaryl, a carbamate insecticide, is relatively safe, controls many kinds of insects, and is the most common garden insecticide used. However,

mites may build up where it is used. Carbaryl is also very toxic to honey bees. Use it as little as possible when plants are in bloom and apply it late in the day when bee activity is reduced.

Malathion is an organophosphate insecticide frequently used in the home garden because it is relatively safe to apply, and its residues disappear quickly. It effectively controls many pests, including aphids, spider mites and bean beetles.

Pyrethrum is a contact botanical insecticide, not a stomach poison, and provides rapid knockdown of many garden insect pests.

Pyrethroids are also very toxic to honey bees and other pollinators and beneficial insects. Pyrethroids are used against a wide variety of insects, including caterpillars, flea beetles and others.

Spinosad is a mixture of spinosyn A and spinosyn D fermentation products derived from the bacterium, *Saccharopolyspora spinosa*. This product is active against caterpillars, leafminers, thrips, Colorado potato beetle and some borers. Spinosad does not have a significant impact on certain parasitoid insects or the natural predaceous insects, spiders and mites in treated crops. It is toxic to bees.

Bacillus thuringiensis subspecies *kurstaki* is a biological insecticide that is sold in most home garden stores under various trade names. This product is extremely effective against various caterpillars (particularly cabbageworms). However, good coverage of plants is necessary since the toxins of this bacterium must be eaten by the caterpillars before they become diseased.

Chemical Control of Insects

The severity and type of pest problems on garden vegetables usually vary considerably from year to year. During most growing seasons, consistent production of high-quality vegetables is assured only with the use of pesticides for control of insects and diseases. This is not to suggest that vegetables cannot be grown without pesticides by using nonchemical methods, but it will usually take more effort on the part of the gardener and some damage (sometimes severe) must be accepted.

The pattern of pesticide use (preventive and

curative) depends largely on the type of pest. Generally, fungicides are used to prevent the establishment of diseases, and insecticides are used after insect infestations are found. However, if you do have an insect pest that usually causes serious damage, an insecticide should be applied when the infestation first develops. Fungicides should be applied before there is evidence of plant damage. Repeat treatments of both fungicides and insecticides should be made every week or 10 days if disease development or insect infestations continue, or as directed by label. More frequent applications may be needed during wet weather. Whether you use a dust or a spray, only those parts of the plant that are actually coated with the fungicide or insecticide are protected unless the pesticide has systemic activity. For more information on diseases of garden plants, see <https://extension.tennessee.edu/publications/Documents/W316.pdf>.

Pesticides may be used as a dust or a spray. Dusts are ready to use when purchased; they require no mixing. They can be applied with less expensive equipment than that needed for sprays. Sprays must usually be mixed by the home gardener, but they are frequently more effective. Some sprays are in ready-to-use form, but they are generally more expensive.

Dusts

Home gardeners usually prefer dusts because they are easier to handle and apply. Dusts should be applied while the air is calm, usually in the early morning or late afternoon. Plunger, bellows and rotary types of hand dusters are satisfactory for home garden use. An applicator that delivers a continuous cloud of dust is generally more effective than one that delivers dust in puffs. Apply an even light coating of dust at the label recommended rate. Force it through the foliage so both sides of the leaves are covered.

Sprays

It is usually necessary to prepare sprays by mixing wettable powders or emulsifiable concentrates with water. Compressed-air, knapsack and bucket pump sprayers are best for applying sprays. The compressed-air sprayer is usually the handiest. Both plastic and metal (stainless steel and

galvanized) sprayers are available. Stainless steel sprayers are more expensive but will last much longer. Plastic sprayers are quite good but must be kept from high temperatures and extended periods in direct sunlight.

If a wettable powder is used, stir it vigorously in a small amount of water to make a smooth suspension. Add the slurry to the full amount of water and stir until completely mixed. When applying a wettable powder spray, shake the applicator frequently to keep the powder from settling to the bottom.

If you use an emulsifiable concentrate, shake the pesticide container well before measuring out the spray mixture.

Advantages or Disadvantages of Dusts versus Spray Applications

Dusts:

Advantages

- Ready-to-use formulations.
- No mixing required.
- Duster less expensive than sprayer.
- Dust formulations less expensive than spray formulations.

Disadvantages

- Do not adhere to plant surfaces as well as sprays.
- Blow in the wind.
- Drift to plant blossoms, injure bees.
- Less effective control.
- Less plant protection.

Sprays:

Advantages

- Better coverage of plant surfaces with mist spray.
- Adhere to plant surface.
- Less toxic to bees.
- Less problem with drifting.
- Higher level of control.
- Better plant protection.

Disadvantages

- Mixing required.
- Agitation of wettable powder spray mixture in sprayer required.

- Formulations more expensive than dusts.

The Compressed Air Sprayer

The nozzle is the most important part of the sprayer for it determines the spray pattern of insecticide delivered to a plant surface. Different nozzle spray patterns include a solid stream, a flat fan spray, hollow cone or solid cone pattern. The nozzle determines the amount of spray output at a given pressure during a specified time. Many garden sprayers have an adjustable nozzle that will deliver two or more spray patterns. To determine the delivery rate of your sprayer in gallons per minute, follow these steps:

1. Fill the sprayer tank with clean water.
2. Pump the air pump until the desired pressure of 20 to 40 psi is reached in the tank.
3. Adjust the nozzle to deliver the desired pattern.
4. Place the spray nozzle in a bucket, can or jar to collect the liquid to be sprayed.
5. Open the valve and discharge the spray liquid into the bucket, can or jar for a specified time period of 20 or 30 seconds.
6. Measure the ounces of water collected.
7. Multiply the ounces collected in 20 seconds by 3 or in 30 seconds by 2 to determine the fraction of a gallon sprayed per minute.

Applying an Insecticide to Plants

Spraying

It is important that the sprayed plants be thoroughly covered. To get thorough coverage, spray the plant from two or three directions and from underneath as well as from above. If the label instructions say “wet thoroughly or to the drip point,” apply a mist spray until the plant begins to drip.

A fine mist of spray will deposit many fine particles on the foliage, resulting in better coverage and a higher level of control.

Using Insecticides Properly to Prevent Pollution

The proper use of insecticides will reduce the pollution of our environment to a minimum. Insecticides are carried into water on soil particles which erode. Take measures necessary to prevent erosion.

DO NOT pour excess spray mixtures or insecticides into sewage systems. Every little bit disposed of in this way adds to the stream pollution problem. Wash the residues from your empty container and mix them into your garden spray. Apply the last drop of the pesticide to your plants.

Cleaned cans or bottles can be delivered to a sanitary landfill. Observe wind conditions and avoid spraying during periods of windy weather to prevent drift.

Mixing a Garden Spray

- Read the label carefully.
- Measure the amount carefully using level teaspoon or tablespoon quantities.
- Mix the insecticide thoroughly in a small volume of water, then bring the liquid up to the desired level.
- Wash all insecticides off the skin immediately.

Applying a Garden Spray

- Adjust sprayer to deliver a fine mist spray.
- Direct spray to infested areas of plant.
- Thoroughly wet plant parts to the point of runoff.
- Apply sprays during periods of favorable weather:
 - 70-85 F — temperature
 - Wind less than 5 miles per hour
 - No rain forecast within 24 hours
- Repeat application if rainfall exceeds ½ inch within 24 hours after applying.
- Keep sprayer in good condition:
 - 1) Wash thoroughly after each use.
 - 2) Hang tank upside down with pump assembly removed for complete drying.
 - 3) Do not use your insecticide or fungicide sprayer for spraying weed killers or vice versa.
 - 4) Buy two sprayers and label them.

Application Rate of Insecticides for Home Gardens

Estimate the amount of spray or dust you will need to cover your garden vegetables for effective control. These rules of thumb for estimating amounts are based on the linear feet of a row or the number of square feet. See the label for actual rates (ounces/square or linear feet).

- One-half gallon will spray 100 feet of row.
- One-half gallon will spray 250 square feet.
- Four ounces (1/4 lb.) of dust will treat 120 feet of row.
- Four ounces (1/4 lb.) of dust will treat 250 square feet.

Row Applications

- Rows 12 inches apart — 43,560 feet of row per acre
- Rows 24 inches apart — 21,780 feet of row per acre
- Rows 36 inches apart — 14,520 feet of row per acre
- Rows 48 inches apart — 10,890 feet of row per acre

Example:

How much spray should you put on 100 feet of row if the nozzles on the spray boom are 24 inches apart and the recommended application rate is 150 gallons per acre?

Calculation:

150 gallons for 21,780 feet = X gallons for 100 feet.

$$X = \frac{150 \times 100}{21,780}$$

Solving for X

$$150 \times 100 = 15,000$$

$$15,000 \div 21,780 = 0.69 \text{ gallons per nozzle per } 100 \text{ ft.}$$

Safe Handling of Insecticides

Home gardeners can control insect pests with reasonable safety by observing these safety rules:

- Keep insecticides in the original, labeled container.
- Keep insecticides in a locked storage cabinet.
- Read the label each time you use the insecticide.
- Measure the amount to be mixed carefully.
- Do not exceed the recommended rate of application.
- Handle the insecticide carefully when mixing to avoid splashing of liquid concentrates and billowing of dusts and powders.
- Wear protective clothing and other personal protection equipment, as directed by the label.
- To protect yourself when mixing insecticides, it is suggested that protective clothing and equipment such as chemical-resistant gloves, a long-sleeve shirt, long pants and protective eyewear be worn.
- Wash all insecticides off the skin immediately, using plenty of soap and water.
- Avoid breathing the spray mist or vapor.
- Always mix insecticides out of doors near a source of water.
- Clean up any spilled materials to prevent children from entering a heavily contaminated area.
- Apply insecticides only to those plants listed on the label.
- Observe the time intervals between the last application and harvest.

Fire Ants

Fire ants occasionally feed on vegetable plants in home gardens. They tunnel into potatoes underground and feed on okra buds and developing pods. The worst damage usually occurs during hot, dry weather. Ants may also be a nuisance to gardeners during weeding and harvesting. See fireants.utk.edu for more information on managing fire ants.

Treatment options

- A bait, Extinguish (methoprene), is labeled for cropland. Another fire ant bait, Esteem (pyriproxyfen), is labeled for some crops such as broccoli, cabbage, cauliflower, kale, mustard greens, cucumber, pumpkins, squash, melons, okra, pepper, tomato, etc. Extinguish and Esteem are insect growth regulators and may require several months to work. Fertilome Come and Get It Fire Ant Killer (spinosad) and Payback Fire Ant Bait with spinosad labels list home garden plants and may require a few weeks to work. Certis Firefighter Fire Ant Bait (spinosad) is also registered for a variety of crops.
- Hi-Yield Vegetable & Ornamental Insect Control Granule, or Monterey Garden Insect Spray (spinosad, OMRI listed) may be used as an individual mound treatment in a variety of

crops such as tomatoes, sweet corn, green peas, sugar snap peas, snow peas, green beans (wax beans, snap beans), dry beans (black-eyed peas, cow pea), cucumber, gourds, muskmelon, pumpkin, squash, and watermelon, broccoli, Chinese broccoli, cabbage, cauliflower, kohlrabi, eggplant, head lettuce, and peppers (bell and non-bell). Natural Guard Spinosad Bagworm, Tent Caterpillar and Chewing Insect Control is also registered for a variety of garden plants.

- Ant mounds can be shoveled out of the garden or treated with very hot water, taking care not to disturb or treat the garden plants. Caution should be taken to prevent hot water and/or steam from injuring the applicator.
- Since most other baits are not registered for use inside gardens, those baits can be applied around the garden perimeter. Foraging ants from colonies both inside and outside the garden will collect the bait and take it to their colonies.
- To prevent ants from entering a garden, apply insecticidal spray or granules around the perimeter of the garden as a barrier, and treat individual mounds near the garden as needed.

Slugs and Snails

Slugs and snails can be controlled in home gardens using iron phosphate (Sluggo, Escar-Go!, Worry Free) or metaldehyde baits. Do not contact plant material with slug baits. Consult the label for specific vegetables it can be used on. Grasshoppers and crickets can be controlled in the home garden using a 5 percent Sevin bait.

Preplant Insecticides for Wireworms, Fire Ants and Other Soil Insects

A single application of 0.115 percent bifenthrin, such as Hi-Yield Vegetable & Ornamental Insect Control Granule, applied just prior to planting or after plants emerge and worked into the top 4 to 6 inches of soil may protect seedlings from wireworms, fire ants or other soil insects. Use 1.0 lb. of product for a 500 sq. ft. area, see label for details.

Organic Pest Management

This publication provides pest management recommendations using predominantly traditional pesticides. For additional organic pesticide suggestions see the green shaded rows in the UT Extension publication W 661 Conventional and Organic Product Overview for Home Vegetable Gardeners in Tennessee available at <https://extension.tennessee.edu/publications/Documents/W661.pdf>.

Home Vegetable Garden Insect Control

| VEGETABLE/INSECT | INSECTICIDE & FORMULATION L=Liquid, D=Dust, G=Granular | AMOUNT OF FORMULATION PER GALLON OF SPRAY (or as otherwise noted)* | MIN. INTERVAL (DAYS) BETWEEN LAST APPLICATION AND HARVEST | REMARKS AND PRECAUTIONS |
|---|--|---|---|---|
| ASPARAGUS asparagus beetle Japanese beetle | carbaryl 22.5% L | 3 Tbsp | 1 | Treat fern and brush growth as beetles appear. Repeat applications as necessary up to 3 times prior to harvest or 5 times per crop but not more often than once every 7 days. |
| | permethrin 2.5% L | 3 Tbsp | 3 | Do not apply more than 4 times per crop. |
| BEANS - check product for specific beans aphids | malathion 50% L (Spectracide) | 1 ½ to 2 tsp | 1 | When available, insecticide-treated seeds should be used to avoid problems with seed corn maggots and other soil insect pests. Apply up to 2 times/yr. waiting at least 7 days between applications. |
| | bifenthrin 0.3% & zeta-cypermethrin 0.075% L | RTS | 3 | Wait at least 7 days between each application. |
| | insecticide soap (potassium salts of fatty acids) 49.52% L | 5 Tbsp | 0 | Repeat applications may be needed. Repeat at weekly to biweekly intervals up to 3 times. Do not make more than 3 sequential applications over a 2-week period. Do not apply during heat of day or when temps exceed 90 F. |
| bean beetles (Mexican bean beetle, bean leaf beetle) | carbaryl 22.5% L | 3 Tbsp | 3 (fresh beans) 21 (dried beans) | For both fresh and dried beans repeat as necessary up to 4 times, but not more than once every 7 days. |
| | 5 D | Apply according to label | 3 (fresh beans) 21 (dried beans) | |
| | bifenthrin 0.3% & Zeta-cypermethrin 0.075% L | RTS | 3 | Wait at least 7 days between each application. |
| | gamma cyhalothrin 0.08% L | Apply according to label. | 7 | Wait at least 7 days between each application. Do not apply more than 9 times per growing season. |
| corn earworm | carbaryl 22.5% L | 3 Tbsp | 3 (fresh beans) 21 (dried beans) | Repeat treatments at 7-day intervals may be needed on late beans. Do not treat fresh or dried beans more than 4 times per season. |
| | 5 D | Apply according to label | 3 (fresh beans) 21 (dried beans) | |
| | bifenthrin 0.3% & zeta-cypermethrin 0.075% L | RTS | 3 | Wait at least 7 days between each application. |

| VEGETABLE/INSECT | INSECTICIDE & FORMULATION L=Liquid, D=Dust, G=Granular | AMOUNT OF FORMULATION PER GALLON OF SPRAY (or as otherwise noted)* | MIN. INTERVAL (DAYS) BETWEEN LAST APPLICATION AND HARVEST | REMARKS AND PRECAUTIONS |
|--------------------------------|--|--|---|---|
| BEANS (cont'd) corn earworm | gamma cyhalothrin 0.08% L | Apply according to label. | 7 | Wait at least 7 days between each application. Do not apply more than 9 times per growing season. |
| | spinosad 0.5% L | 4 Tbsp | 3 succulent beans 28 dried beans | Maximum of 6 applications per year. Wait 5 days before reapplying. |
| cowpea curculio | See peas. | | | |
| spider mites | insecticide soap (potassium salts of fatty acids) 49.52% | 5 Tbsp | 0 | Begin at first signs of mites and off-color. Repeat applications may be needed, especially during hot weather. Repeat at weekly to biweekly intervals up to 3 times. Do not make more than 3 sequential applications over a 2-week period. Do not apply during heat of day or when temps exceed 90 F. |
| | malathion 50% L (Spectracide) | 1 Tbsp | 1 | Apply up to 2 times/yr. waiting at least 7 days between applications. |
| stink bug | bifenthrin 0.3% & zeta-cypermethrin 0.075% L | RTS | 3 | Wait at least 7 days between each application. |
| thrips, lima bean borer | spinosad 0.5% | 4 Tbsp | 3 succulent beans 28 dried beans | Maximum of 6 applications per season; Wait 5 days before reapplying. |
| whitefly | bifenthrin 0.3% & zeta-cypermethrin 0.075% L | RTS | 3 | Wait at least 7 days between each application. |
| | insecticide soap (potassium salts of fatty acids) 49.52% L | 5Tbsp | 0 | Repeat applications may be needed. Repeat at weekly to biweekly intervals up to 3 times. Do not make more than 3 sequential applications over a 2-week period. Do not apply during heat of day or when temps exceed 90 F. |
| BEETS, GARDEN flea beetles | carbaryl 22.5 % L | 3 Tbsp | 7 | Repeat up to 6 times but not more often then once every 7 days. |
| BROCCOLI aphid | malathion 50% L (Spectracide) | 1 ½ to 2 tsp | 2 | Apply up to 2 times/yr. waiting at least 7 days between applications. |
| | bifenthrin 0.3% & zeta-cypermethrin 0.075% L | RTS | 7 | Wait at least 7 days between each application. |

| VEGETABLE/INSECT | INSECTICIDE & FORMULATION L=Liquid, D=Dust, G=Granular | AMOUNT OF FORMULATION PER GALLON OF SPRAY (or as otherwise noted)* | MIN. INTERVAL (DAYS) BETWEEN LAST APPLICATION AND HARVEST | REMARKS AND PRECAUTIONS | |
|-----------------------------------|--|--|---|--|---|
| BROCCOLI (cont'd) aphid | insecticide soap (potassium salts of fatty acids) 49.52% L | 5 Tbsp | 0 | For suppression. Repeat applications may be needed. Repeat at weekly to biweekly intervals up to 3 times. Do not make more than 3 sequential applications over a 2 week period. Do not apply during heat of day or when temps exceed 90 F. | |
| | Bacillus thuringiensis subsp. kurstaki | As recommended on the label. | 0 | Treat as soon as damage is found and repeat weekly. | |
| | esfenvalerate 0.425% L | As recommended on the label. | 3 | Wait at least 7 days between each application. | |
| | permethrin 2.5% L | 2 Tbsp | 1 | Do not apply more than 8 applications and not more often than every 5 days. | |
| cabbageworms | spinosad 0.5% L | 4 Tbsp | 1 | Maximum of 6 applications per season. Wait 4 days before reapplying. | |
| | stink bugs | carbaryl 22.5 % L | 3 Tbsp | 3 | Repeat as necessary up to 4 times, but not more than once every 7 days. |
| | bifenthrin 0.3% & zeta-cypermethrin 0.075% L | RTS | 7 | Wait at least 7 days between each application. | |
| BRUSSELS SPROUTS aphid | malathion 50% L (Spectracide) | 1 ½ to 2 tsp | 2 | Apply up to 2 times/yr. waiting at least 7 days between applications. | |
| | insecticide soap (potassium salts of fatty acids) 49.52% L | 5 Tbsp | 0 | For suppression. Repeat applications may be needed. Repeat at weekly to biweekly intervals up to 3 times. Do not make more than 3 sequential applications over a 2-week period. Do not apply during heat of day or when temps exceed 90 F. | |
| cabbageworms | Bacillus thuringiensis subsp. kurstaki | As recommended on the label. | 0 | Begin treatment when first noted and repeat weekly until harvest. | |
| | permethrin 2.5% L | 2 Tbsp | 1 | Do not apply more than 8 applications and not more often than every 5 days. | |
| | spinosad 0.5% L | 4 Tbsp | 1 | Maximum of 6 applications per season. Wait 4 days before reapplying. | |

| VEGETABLE/INSECT | INSECTICIDE & FORMULATION L=Liquid, D=Dust, G=Granular | AMOUNT OF FORMULATION PER GALLON OF SPRAY (or as otherwise noted)* | MIN. INTERVAL (DAYS) BETWEEN LAST APPLICATION AND HARVEST | REMARKS AND PRECAUTIONS |
|----------------------------|---|--|---|---|
| CABBAGE aphid | bifenthrin 0.3% & zeta-cypermethrin 0.075% L | RTS | 7 | Wait at least 7 days between each application. |
| | insecticide soap (potassium salts of fatty acids) 49.52% L | 5Tbsp | 0 | Repeat applications may be needed. Repeat at weekly to biweekly intervals up to 3 times. Do not make more than 3 sequential applications over a 2-week period. Do not apply during heat of day or when temps exceed 90 F. |
| cabbage maggot and cutworm | bifenthrin 0.115% G | Use 1 lb. product per 500 sq. ft. | 7 | A single application may be applied just prior to planting or after plants emerge and worked into the top 4 to 6 inches of soil. |
| cutworm | bifenthrin 0.3% & zeta-cypermethrin 0.075% L | RTS | 7 | Wait at least 7 days between each application. |
| cabbageworms | Bacillus thuringiensis subsp. kurstaki | As recommended on the label. | 0 | Good coverage is essential. Upper and lower leaves. Treat as soon as damage is found and repeat weekly until harvest. |
| | permethrin 2.5% L | 2 Tbsp | 1 | Do not apply more than 10 times. |
| | esfenvalerate 0.425% L | As recommended on the label. | 3 | Wait at least 7 days between each application. |
| | spinosad 0.5% L | 4 Tbsp | 1 | Maximum of 6 applications per season. Wait 4 days before reapplying. |
| flea beetles | carbaryl 22.5% L | 3 Tbsp | 3 | On foliage, as needed Repeat as necessary up to 4 times, but not more than once every 7 days. |
| harlequin bug | carbaryl 22.5% L | 3 Tbsp | 3 | Apply when necessary but not more than 4 times; wait at least 7 days between applications. |
| CANTALOUPE aphid | bifenthrin 0.3% & zeta-cypermethrin 0.075% L | RTS | 3 | Wait at least 7 days between each application. |
| | insecticide soap (potassium salts of fatty acids) 49.52% L | 5 Tbsp | 0 | Repeat applications may be needed. Repeat at weekly to biweekly intervals up to 3 times. Do not make more than 3 sequential applications over a 2-week period. Do not apply during heat of day or when temps exceed 90 F. |

| VEGETABLE/INSECT | INSECTICIDE & FORMULATION L=Liquid, D=Dust, G=Granular | AMOUNT OF FORMULATION PER GALLON OF SPRAY (or as otherwise noted)* | MIN. INTERVAL (DAYS) BETWEEN LAST APPLICATION AND HARVEST | REMARKS AND PRECAUTIONS |
|---|--|--|---|---|
| CANTALOUPE (cont'd) cucumber beetles | carbaryl 22.5% L | 3 Tbsp | 3 | Repeat as necessary up to 6 times, but not more than once every 7 days. |
| | bifenthrin 0.3% & zeta-cypermethrin 0.075% L | RTS | 3 | Wait at least 7 days between each application. |
| | permethrin 2.5% L | As recommended on the label. | 0 | Do not apply more than 8 times per year. For use on adult beetles. |
| leafminer | spinosad 0.5% L | 4 Tbsp | 3 | Maximum of 6 applications per season. Wait 5 days before reapplying. |
| pickleworm | carbaryl 22.5 % L | 3 Tbsp | 3 | Late-planted cantaloupes are heavily attacked. Begin treatments at first bloom; repeat as necessary up to 6 times, but not more than once every 7 days. |
| | bifenthrin 0.3% & zeta-cypermethrin 0.075% L | RTS | 3 | Wait at least 7 days between each application. |
| | permethrin 2.5% L | As recommended on the label. | 0 | Do not apply more than 8 times per year. |
| | spinosad 0.5% L | 4 Tbsp | 3 | Maximum of 6 applications per season; wait 5 days before reapplying. |
| spider mite | insecticide soap (potassium salts of fatty acids) 49.52% L | 5Tbsp | 0 | Repeat applications may be needed. Repeat at weekly to biweekly intervals up to 3 times. Do not make more than 3 sequential applications over a 2-week period. Do not apply during heat of day or when temps exceed 90 F. |
| COLLARDS aphid | malathion 50% L (Bonide) | 3 tsp | 7 | Make 2 or more applications as needed. Apply when necessary, waiting at least 7 days between applications. |
| cabbageworms | Bacillus thuringiensis subsp. kurstaki | As recommended on the label. | 0 | Begin treatments as soon as damage is found and repeat weekly until harvest. |
| | esfenvalerate 0.425% L | As recommended on the label. | 7 | Wait at least 7 days between each application. |
| | spinosad 0.5% | 4 Tbsp | 1 | Maximum of 6 applications per season. Wait 4 days before reapplying. |

| VEGETABLE/INSECT | INSECTICIDE & FORMULATION L=Liquid, D=Dust, G=Granular | AMOUNT OF FORMULATION PER GALLON OF SPRAY (or as otherwise noted)* | MIN. INTERVAL (DAYS) BETWEEN LAST APPLICATION AND HARVEST | REMARKS AND PRECAUTIONS |
|---|---|--|---|---|
| COLLARDS (cont'd) flea beetles | carbaryl 22.5 % L | 3 Tbsp | 14 | On foliage as needed. Repeat as necessary up to 4 times, but not more than once every 7 days. |
| | esfenvalerate 0.425% L | As recommended on the label. | 7 | Wait at least 7 days between each application. |
| harlequin bug | malathion 50% L (Bonide) | 1 Tbsp | 7 | Make 2 or more applications as needed. Apply when necessary, waiting at least 7 days between applications |
| | carbaryl 22.5% L | 3 Tbsp | 14 | Repeat as necessary up to 4 times, but not more than once every 7 days. |
| CORN, SWEET corn earworm, fall armyworm, European corn borer | bifenthrin 0.3% & zeta-cypermethrin 0.075% L | RTS | 3 | Wait at least 7 days between each application. |
| | carbaryl 22.5% L | 3 Tbsp | 2 | Begin treating when silks appear. Repeat with sprays directed at ears as necessary up to 8 times, but not more than once every 7 days. |
| | cyfluthrin 0.75% L | Ready-to-spray formula | 0 | Apply to flowering plants during early morning or late evening, when bees are not present. Do not apply ready-to-spray more than 5 times per season nor concentrate more than 10 times. |
| | cyfluthrin 0.75% L | 1 Tbsp | 0 | |
| | esfenvalerate 0.425% L | As recommended on the label. | 1 | Wait at least 7 days between each application. |
| | permethrin 2.5% L | 3 Tbsp | 1 | Apply L as needed every 5 days, but do not apply more than 6 times per season. |
| | spinosad 0.5% L | 4 Tbsp | 1 | Maximum of 6 applications per season. Wait 3 days before reapplying. |
| flea beetle | bifenthrin 0.3% & zeta-cypermethrin 0.075% L | RTS | 3 | Wait at least 7 days between each application. |
| | carbaryl 22.5% L | 3 Tbsp | 2 | Early application on seedling corn is usually necessary. Repeat up to 8 times, but not more than once every 7 days. Application during pollen shed will seriously reduce bee populations. |

| VEGETABLE/INSECT | INSECTICIDE & FORMULATION L=Liquid, D=Dust, G=Granular | AMOUNT OF FORMULATION PER GALLON OF SPRAY (or as otherwise noted)* | MIN. INTERVAL (DAYS) BETWEEN LAST APPLICATION AND HARVEST | REMARKS AND PRECAUTIONS |
|----------------------|---|--|---|---|
| CORN, SWEET (cont'd) | cyfluthrin 0.75% L | Ready-to-spray formula | 0 | Apply to flowering plants during early morning or late evening, when bees are not present. Do not apply ready-to-spray more than 5 times per season nor concentrate more than 10 times. |
| | flea beetle cyfluthrin 0.75% L | 1 Tbsp | 0 | |
| | stink bug cyfluthrin 0.75% L | Ready-to-spray | 0 | |
| CUCUMBER | aphid insecticide soap (potassium salts of fatty acids) 49.52% L | 5Tbsp | 0 | For suppression. Repeat applications may be needed. Repeat at weekly to biweekly intervals up to 3 times. Do not make more than 3 sequential applications over a 2-week period. Do not apply during heat of day or when temps exceed 90 F. Apply to cucumbers at night or during coolest part of day. |
| | bifenthrin 0.3% & zeta-cypermethrin 0.075% L | RTS | 3 | Wait at least 7 days between each application. |
| | carbaryl 22.5% L | 3 Tbsp | 3 | Apply Sevin late in the day to minimize killing pollinating insects. Repeat up to 6 times, but not more than once every 7 days. |
| | 5 D | Apply according to label. | 3 | |
| | bifenthrin 0.3% & zeta-cypermethrin 0.075% L | RTS | 3 | Wait at least 7 days between each application. |
| | esfenvalerate 0.425% L | As recommended on the label. | 3 | For use on cucumber beetle adults. Wait at least 7 days between each application. |
| | cucumber beetle, squash bug | malathion 50% L (Bonide) | 3 tsp or 1 Tbsp | 1 |
| permethrin 2.5% L | | As recommended on the label | 0 | For use on cucumber beetle adults. Do not apply more than 8 times per year. |
| spider mites | insecticide soap (potassium salts of fatty acids) 49.52% L | 5Tbsp | 0 | For suppression. Repeat applications may be needed. Repeat at weekly to biweekly intervals up to 3 times. Do not make more than 3 sequential applications over a 2-week period. Do not apply during heat of day or when temps exceed 90 F. Apply to cucumbers at night or during coolest part of day. |

| VEGETABLE/INSECT | INSECTICIDE & FORMULATION L=Liquid, D=Dust, G=Granular | AMOUNT OF FORMULATION PER GALLON OF SPRAY (or as otherwise noted)* | MIN. INTERVAL (DAYS) BETWEEN LAST APPLICATION AND HARVEST | REMARKS AND PRECAUTIONS |
|------------------------|--|--|---|--|
| EGGPLANT aphids | bifenthrin 0.3% & zeta-cypermethrin 0.075% L | RTS | 7 | Wait at least 7 days between each application. |
| | malathion 50% L (Bonide) | 4 tsp | 3 | Apply treatment when aphids present and repeat when needed. Make 2 or more applications. Wait at least 7 days between each application |
| | insecticide soap (potassium salts of fatty acids) 49.52% L | 5Tbsp | 0 | For suppression. Repeat applications may be needed. Repeat at weekly to biweekly intervals up to 3 times. Do not make more than 3 sequential applications over a 2-week period. Do not apply during heat of day or when temps exceed 90 F. |
| Colorado potato beetle | carbaryl 22.5% L | 3 Tbsp | 3 | On foliage as needed. Repeat up to 7 times, but not more than once every 7 days. |
| | bifenthrin 0.3% & zeta-cypermethrin 0.075% L | RTS | 7 | Wait at least 7 days between each application. |
| | esfenvalerate 0.425% L | As recommended on the label. | 7 | Wait at least 7 days between each application. |
| | permethrin 2.5% L 0.25% D | 6 Tbsp Apply according to label. | 3 | Do not apply L formulation more than 16 times. Do not apply D formulation more than 10 times per season. |
| Colorado potato beetle | spinosad 0.5% L | 4 Tbsp | 1 | Maximum of 6 applications per season. Wait 4 days before reapplying. |
| flea beetle | carbaryl 22.5% L | 3 Tbsp | 3 | On foliage as needed. Repeat up to 7 times, but not more than once every 7 days. |
| | bifenthrin 0.3% & zeta-cypermethrin 0.075% L | RTS | 7 | Wait at least 7 days between each application. |
| lacebug | malathion 50% L (Bonide) | 4 tsp | 3 | Wait at least 7 days between each application. |
| spider mite | malathion 50% L (Bonide) | 4 tsp | 3 | Repeat treatments are often necessary. Do not use Kelthane! Wait at least 7 days between each application. |

| VEGETABLE/INSECT | INSECTICIDE & FORMULATION L=Liquid, D=Dust, G=Granular | AMOUNT OF FORMULATION PER GALLON OF SPRAY (or as otherwise noted)* | MIN. INTERVAL (DAYS) BETWEEN LAST APPLICATION AND HARVEST | REMARKS AND PRECAUTIONS |
|----------------------------------|---|--|---|--|
| EGGPLANT (cont'd) spider mite | insecticide soap (potassium salts of fatty acids) 49.52% L | 5Tbsp | 0 | For suppression. Repeat applications may be needed. Repeat at weekly to biweekly intervals up to 3 times. Do not make more than 3 sequential applications over a 2-week period. Do not apply during heat of day or when temps exceed 90 F. |
| | cyfluthrin 0.75% L | Ready-to-spray | 7 | Do not spray more than 6 times per season. |
| | pyrethrin (aerosol) | | 1 | |
| whitefly | bifenthrin 0.3% & zeta-cypermethrin 0.075% L | RTS | 7 | Wait at least 7 days between each application. |
| | insecticide soap (potassium salts of fatty acids) 49.52% L | 5 Tbsp | 0 | For suppression. Repeat applications may be needed. Repeat at weekly to biweekly intervals up to 3 times. Do not make more than 3 sequential applications over a 2-week period. Do not apply during heat of day or when temps exceed 90 F. |
| | | | | |
| LETTUCE aphid | malathion 50% L (Spectracide) | 1 ½ to 2 tsp. | 14 | Apply up to 2 times/yr. Wait 6 days between application for head lettuce and 5 days for leaf lettuce. |
| | bifenthrin 0.3% & zeta-cypermethrin 0.075% L | RTS | 7 | Wait at least 7 days between each application. |
| cabbageworms | Bacillus thuringiensis subsp. kurstaki | As recommended on the label | 0 | Begin treatments as soon as damage is found and repeat weekly until harvest. |
| | bifenthrin 0.3% & zeta-cypermethrin 0.075% L | RTS | 7 | Wait at least 7 days between each application. |
| | permethrin 2.5% L | 4 Tbsp | 1 | Apply every 5 to 10 days as needed, but do not apply formulation more than 10 times per season. |
| | spinosad 0.5% L | 4 Tbsp | 1 | Maximum of 6 applications per season. Wait 4 days before reapplying. |
| MUSTARD GREENS aphid | malathion 50% L (Bonide) | 3 tsp | 7 | Wait at least 7 days between each application. |

| VEGETABLE/INSECT | INSECTICIDE & FORMULATION L=Liquid, D=Dust, G=Granular | AMOUNT OF FORMULATION PER GALLON OF SPRAY (or as otherwise noted)* | MIN. INTERVAL (DAYS) BETWEEN LAST APPLICATION AND HARVEST | REMARKS AND PRECAUTIONS | |
|-----------------------------------|---|--|---|--|--|
| MUSTARD GREENS (cont'd) | aphid | bifenthrin 0.3% & zeta-cypermethrin 0.075% L | RTS | 7 | Wait at least 7 days between each application. |
| | caterpillars | Bacillus thuringiensis subsp. kurstaki | As recommended on the label. | 0 | Begin treatments as soon as damage is found and repeat weekly or as necessary until harvest. |
| | | spinosad 0.5% L | 4 Tbsp | 1 | Maximum of 6 applications per season. Wait 4 days before reapplying. |
| flea beetles | carbaryl 22.5% L | 3 Tbsp | 14 | Repeat up to 4 times, but not more than once every 7 days. | |
| OKRA | aphids | insecticide soap (potassium salts of fatty acids) 49.52% L | 5Tbsp | 0 | Repeat applications may be needed. Repeat at weekly to biweekly intervals up to 3 times. Do not make more than 3 sequential applications over a 2-week period. Do not apply during heat of day or when temps exceed 90 F. |
| | | permethrin 2.5% L | 4 Tbsp | 1 | Every 5 to 10 days as needed, but do not apply L formulation more than 10 times per season. |
| | stink bug | carbaryl 22.5% L | 3 Tbsp | 3 | Repeat up to 7 times, but not more than once every 7 days. |
| cyfluthrin 0.75% L | | Ready-to-spray | 0 | Do not spray more than 4 times per season. | |
| ONIONS | thrips | malathion 50% L (Bonide) | 2 ½ tsp | 3 | Wait at least 7 days between each application. |
| PEAS | aphid | malathion 50% L (Spectracide) | 1 ½ to 2 tsp | 3 | Make up to 2 applications per yr. Wait at least 7 days between each application. |
| | | insecticide soap (potassium salts of fatty acids) 49.52% L | 5 Tbsp | 0 | For suppression. Repeat applications may be needed. Repeat at weekly to biweekly intervals up to 3 times. Do not make more than 3 sequential applications over a 2-week period. Do not apply during heat of day or when temps exceed 90 F. |
| cowpea curculio | esfenvalerate 0.425% L | As recommended on the label. | 3 (fresh peas) 21 (dried peas) | 3 (fresh peas) 21 (dried peas) | Wait at least 7 days between each application. |
| European corn borer | carbaryl 22.5% L | 3 Tbsp | 3 (fresh peas) 21 (dried peas) | 3 (fresh peas) 21 (dried peas) | This insect is a more serious pest on late peas. Treat 1 to 2 weeks prior to bloom. Repeat applications as necessary up to 4 times, but not more often than once every 7 days. |

| VEGETABLE/INSECT | INSECTICIDE & FORMULATION L=Liquid, D=Dust, G=Granular | AMOUNT OF FORMULATION PER GALLON OF SPRAY (or as otherwise noted)* | MIN. INTERVAL (DAYS) BETWEEN LAST APPLICATION AND HARVEST | REMARKS AND PRECAUTIONS |
|---|---|--|---|--|
| PEAS (cont'd) European corn borer | esfenvalerate 0.425% L | As recommended on the label. | 3 (green peas) 21 (dried peas) | Wait at least 7 days between each application. |
| | spinosad 0.5% L | 4 Tbsp | 3 succulent peas 28 dried peas | Maximum of 6 applications per season. Wait 5 days before reapplying. |
| lesser cornstalk borer | spinosad 0.5% L | 4 Tbsp | 3 | A problem on late peas. Maximum of 6 applications per season. Wait 5 days before reapplying. |
| stink bug | bifenthrin 0.3% & zeta-cypermethrin 0.075% L | RTS | 3 | Wait at least 7 days between each application. |
| PEPPER aphid | bifenthrin 0.3% & zeta-cypermethrin 0.075% L | RTS | 7 | Wait at least 7 days between each application. |
| | malathion 50% L (Bonide) | 2 ½ tsp | 3 | Wait at least 7 days between each application. |
| | insecticide soap (potassium salts of fatty acids) 49.52% L | 5Tbsp | 0 | For suppression. Repeat applications may be needed. Repeat at weekly to biweekly intervals up to 3 times. Do not make more than 3 sequential applications over a 2-week period. Do not apply during heat of day or when temps exceed 90 F. |
| armyworms, cabbage loopers, corn earworms, leafminers | cyfluthrin 0.75% L | Ready-to-spray formula | 7 | Apply to flowering plants during early morning or late evening, when bees are not present. Do not apply more than 6 times per season. |
| | cyfluthrin 0.75% L | 1 Tbsp | 7 | |
| | spinosad 0.5% L | 4 Tbsp | 1 | |
| flea beetle | carbaryl 22.5% L | 3 Tbsp | 3 | Repeat applications as necessary up to 7 times, but not more often than once every 7 days. |
| European corn borer | carbaryl 22.5% L | 3 Tbsp | 3 | Spray plants thoroughly, especially pepper caps, every 7 days after blossoms appear and fruit forms, but not more than 7 times. |
| | cyfluthrin 0.75% L | Ready-to-spray formula | 7 | Apply to flowering plants during early morning or late evening, when bees are not present. Do not apply more than 6 times per year. |
| | cyfluthrin 0.75% L | 1 Tbsp | | |

| VEGETABLE/INSECT | INSECTICIDE & FORMULATION L=Liquid, D=Dust, G=Granular | AMOUNT OF FORMULATION PER GALLON OF SPRAY (or as otherwise noted)* | MIN. INTERVAL (DAYS) BETWEEN LAST APPLICATION AND HARVEST | REMARKS AND PRECAUTIONS |
|--|---|--|---|--|
| PEPPER (cont'd) European corn borer | esfenvalerate 0.425% L | As recommended on the label. | 7 | Wait at least 7 days between each application. |
| | permethrin 2.5% L | 4 Tbsp | 3 | Do not apply more than 8 times per season. |
| | spinosad 0.5% L | 4 Tbsp | 1 | Maximum of 6 applications per season. Wait 4 days before reapplying. |
| stink bug | cyfluthrin 0.75% L | Ready-to-spray | 7 | Do not spray more than 6 times per season. |
| POTATOES, IRISH aphid | esfenvalerate 0.425% L | As recommended on the label. | 7 | Wait at least 7 days between each application. |
| Colorado potato beetle | malathion 50% L (Bonide) | 1 ½ tsp | 0 | Wait at least 7 days between each application. |
| | permethrin 2.5% L | 3 Tbsp | 7 14 | Do not apply formulation more than 12 times. |
| | spinosad 0.5% L | 4 Tbsp | 7 | Maximum of 6 applications per season. Wait 7 days before reapplying. |
| flea beetle, leafhoppers | carbaryl 22.5% L | 3 Tbsp | 7 | Repeat applications as necessary up to 6 times, but not more often than once every 7 days. |
| | 5 D | Apply according to label. | 6 | |
| potato tuberworm | esfenvalerate 0.425% L | As recommended on the label. | 7 | Wait at least 7 days between each application. |
| | permethrin 2.5% L | 3 Tbsp | 7 | Do not apply L formulation more than 12 times. |
| | spinosad 0.5% L | 4 Tbsp | 7 | Maximum of 6 applications per season. Wait 7 days before reapplying. |
| RADISHES aphid | malathion 50% L (Spectracide) | 1 ½ to 2 tsp | 7 | Make up to 3 applications per year. Wait at least 7 days between each application. |
| | esfenvalerate 0.425% L | As recommended on the label. | 7 | Wait at least 7 days between each application. |

| VEGETABLE/INSECT | INSECTICIDE & FORMULATION L=Liquid, D=Dust, G=Granular | AMOUNT OF FORMULATION PER GALLON OF SPRAY (or as otherwise noted)* | MIN. INTERVAL (DAYS) BETWEEN LAST APPLICATION AND HARVEST | REMARKS AND PRECAUTIONS |
|--------------------------------|--|--|---|---|
| RADISHES (cont'd) cutworms | cyfluthrin 0.75% L | Ready-to-spray formula | 0 | Do not apply more than 5 times per season. |
| | cyfluthrin 0.75% L | 1 Tbsp | | |
| | esfenvalerate 0.425% L | As recommended on the label. | 7 | Wait at least 7 days between each application. |
| flea beetles | carbaryl 22.5% L | 3 Tbsp | 7 | Do not apply L formulation more than 6 times. Do not apply D formulation more than 4 times per season. |
| | 5 D | Apply according to label. | 7 | |
| | cyfluthrin 0.75% L | Ready-to-spray formula | 0 | Do not apply more than 5 times per season. |
| | cyfluthrin 0.75% L | 1 Tbsp | | |
| SQUASH & PUMPKIN aphid | bifenthrin 0.3% & zeta-cypermethrin 0.075% L | RTS | 3 | Wait at least 7 days between each application. |
| | malathion 50% L (Bonide) | 3 tsp | 3 Pumpkin 1 squash | Do not apply unless leaves are dry. Wait at least 7 days between each application. |
| | insecticide soap (potassium salts of fatty acids) 49.52% L | 5 Tbsp | 0 | For summer squash. For suppression. Repeat applications may be needed. Repeat at weekly to biweekly intervals up to 3 times. Do not make more than 3 sequential applications over a 2-week period. Do not apply during heat of day or when temps exceed 90 F. |
| cucumber beetles, flea beetles | carbaryl 22.5% L | 3 Tbsp | 3 | Apply Sevin late in the day to minimize killing pollinating insects. Leaf injury may occur if tender foliage is wet or humidity is high. Repeat applications as necessary up to 6 times, but not more often than once every 7 days. |
| | 5 D | Apply according to label. | 3 | |
| | bifenthrin 0.3% & zeta-cypermethrin 0.075% L | RTS | 3 | Wait at least 7 days between each application. |
| | esfenvalerate 0.425% L | As recommended on the label. | 3 | Wait at least 7 days between each application. |
| | permethrin 2.5% L | 4 Tbsp | 0 0 | Do not apply more than 8 times per year. |
| leafminer | spinosad 0.5% L | 4 Tbsp | 3 | Maximum of 6 applications per season. Wait 5 days before reapplying. |

| VEGETABLE/INSECT | INSECTICIDE & FORMULATION L=Liquid, D=Dust, G=Granular | AMOUNT OF FORMULATION PER GALLON OF SPRAY (or as otherwise noted)* | MIN. INTERVAL (DAYS) BETWEEN LAST APPLICATION AND HARVEST | REMARKS AND PRECAUTIONS |
|---|--|--|---|---|
| SQUASH & PUMPKIN (cont'd) pickleworm, squash vine borer | carbaryl 22.5% L | 3 Tbsp | 3 | Treat when damage to blossoms or other plant parts is noticed. More of a problem on late squash than early. Direct sprays at base of plants for vine borer control. Repeat applications as necessary up to 6 times, but not more often than once every 7 days. |
| | esfenvalerate 0.425% L | As recommended on the label. | 3 | Wait at least 7 days between each application. |
| | bifenthrin 0.3% & zeta-cypermethrin 0.075% L | RTS | 3 | Wait at least 7 days between each application. |
| | spinosad 0.5% L | 4 Tbsp | 3 | Maximum of 6 applications per season; wait 5 days before reapplying. |
| squash bug | bifenthrin 0.3% & zeta-cypermethrin 0.075% L | RTS | 3 | Wait at least 7 days between each application. |
| | esfenvalerate 0.425% L | As recommended on the label. | 3 | Wait at least 7 days between each application. |
| | permethrin 2.5% L | As recommended on the label. | 0 | Do not apply more than 8 times per season. |
| stink bug | cyfluthrin 0.75% L | Ready-to-spray | 0 | Do not spray more than 4 times per season. |
| TOMATO aphid | bifenthrin 0.3% & zeta-cypermethrin 0.075% L | RTS | 1 | Wait at least 7 days between each application. |
| | malathion 50% L (Spectracide) | 1 ½ to 2 tsp | 1 | Make up to 4 applications per yr. at least 5 days apart. |
| | insecticide soap (potassium salts of fatty acids) 49.52% L | 5Tbsp | 0 | For suppression. Repeat applications may be needed. Repeat at weekly to biweekly intervals up to 3 times. Do not make more than 3 sequential applications over a 2-week period. Do not apply during heat of day or when temps exceed 90 F. Apply to cucumbers at night or during coolest part of day. |

| VEGETABLE/INSECT | INSECTICIDE & FORMULATION L=Liquid, D=Dust, G=Granular | AMOUNT OF FORMULATION PER GALLON OF SPRAY (or as otherwise noted)* | MIN. INTERVAL (DAYS) BETWEEN LAST APPLICATION AND HARVEST | REMARKS AND PRECAUTIONS |
|--|---|--|---|--|
| TOMATO (cont'd) beetles, blister beetles | carbaryl 22.5% L 5 D | 3 Tbsp Apply according to label | 3 3 | Flea beetles are more destructive on new set plants. Blister beetles are more common later in the season. Repeat applications as necessary up to 7 times, but not more often than once every 7 days. |
| | bifenthrin 0.3% & zeta-cypermethrin 0.075% L | RTS | 1 | Wait at least 7 days between each application. |
| | gamma cyhalothrin 0.08% L | Apply according to label. | 5 | Wait at least 7 days between each application. Do not apply more than 9 times per growing season. |
| cutworms | cyfluthrin 0.75% L | Ready-to-spray formula | 0 | Apply to flowering plants during early morning or late evening, when bees are not present. Do not apply more than 6 times per season. |
| | cyfluthrin 0.75% L | 1 Tbsp | | |
| | carbaryl 22.5% L | 3 Tbsp | 3 | Mix in enough water to get sufficient coverage of plants and soil around plants. Repeat applications as necessary up to 7 times, but not more often than once every 7 days. |
| | esfenvalerate 0.425% L | As recommended on the label. | 1 | Wait at least 7 days between each application. |
| | permethrin 2.5% L | 3 Tbsp | 0 | Do not apply formulation more than 8 times per season. |
| Colorado potato beetle | carbaryl 22.5% L | 3 Tbsp | 3 | Repeat applications as necessary up to 7 times, but not more often than once every 7 days. |
| | bifenthrin 0.3% & zeta-cypermethrin 0.075% L | RTS | 1 | Wait at least 7 days between each application. |
| | permethrin 2.5% L | 3 Tbsp | 0 | Do not apply formulation more than 8 times per season. |
| | spinosad 0.5% L | 4 Tbsp | 1 | Maximum of 6 applications per season; wait 4 days before reapplying. |
| leafminer | spinosad 0.5% L | 4 Tbsp | 1 | Maximum of 6 applications per season; wait 4 days before reapplying. |
| spider mite | insecticide soap (potassium salts of fatty acids) 49.52% L | 5 Tbsp | 0 | No more than 3 applications in 2-weeks. Do not apply in heat of day when leaf temp above 90 F. |

| VEGETABLE/INSECT | INSECTICIDE & FORMULATION L=Liquid, D=Dust, G=Granular | AMOUNT OF FORMULATION PER GALLON OF SPRAY (or as otherwise noted)* | MIN. INTERVAL (DAYS) BETWEEN LAST APPLICATION AND HARVEST | REMARKS AND PRECAUTIONS |
|-------------------------------|---|--|---|--|
| TOMATO (cont'd) | | | | |
| spider mite | malathion 50% L (Spectracide) | 1 Tbsp | 1 | Make up to 4 applications per yr. at least 5 days apart. |
| stink bug and leaf-footed bug | carbaryl 22.5% L | 3 Tbsp | 3 | Repeat applications as necessary up to 7 times, but not more often than once every 7 days. |
| | cyfluthrin 0.75% L | Ready-to-spray formula | 0 | Apply to flowering plants during early morning or late evening, when bees are not present. Do not apply more than 6 times per season. |
| | cyfluthrin 0.75% L | 1 Tbsp | | |
| | esfenvalerate 0.425% L | As recommended on the label. | 1 | Wait at least 7 days between each application. |
| | bifenthrin 0.3% & zeta-cypermethrin 0.075% L | RTS | 1 | Wait at least 7 days between each application. |
| tomato fruitworm and hornworm | Bacillus thuringiensis subsp. kurstaki | As recommended on the label | 0 | Begin treatments when damage is first noted and repeat weekly until harvest. Handpicking of hornworms is often sufficient if few plants are involved. |
| | carbaryl 22.5% L | 3 Tbsp | 3 | Repeat applications as necessary up to 7 times, but not more often than once every 7 days. |
| | cyfluthrin 0.75% L | Ready-to-spray formula | 0 | Apply to flowering plants during early morning or late evening, when bees are not present. Do not apply more than 6 times per season. |
| | cyfluthrin 0.75% L | 1 Tbsp | | |
| | bifenthrin 0.3% & zeta-cypermethrin 0.075% L | RTS | 1 | Wait at least 7 days between each application. |
| | esfenvalerate 0.425% L | As recommended on the label. | 1 | Wait at least 7 days between each application. |
| | permethrin 2.5% L | 3 Tbsp | 0 | Do not apply L formulation more than 8 times per season. |
| | | | 0 | |
| | spinosad 0.5% L | 4 Tbsp | 1 | Maximum of 6 applications per season. Wait 4 days before reapplying. |
| whitefly | Pyrethrin (aerosol) | According to label. | 0 | Inspect undersides of leaves when purchasing transplants. Do not buy if whiteflies are observed. Spray underside of leaves; repeated weekly applications needed for control. |

| VEGETABLE/INSECT | INSECTICIDE & FORMULATION L=Liquid, D=Dust, G=Granular | AMOUNT OF FORMULATION PER GALLON OF SPRAY (or as otherwise noted)* | MIN. INTERVAL (DAYS) BETWEEN LAST APPLICATION AND HARVEST | REMARKS AND PRECAUTIONS | |
|------------------|---|--|---|--|--|
| TOMATO (cont'd) | whitefly | bifenthrin 0.3% & zeta-cypermethrin 0.075% L | RTS | 1 | Wait at least 7 days between each application. |
| | | insecticide soap (potassium salts of fatty acids) 49.52% L | 5 Tbsp | 0 | No more than 3 applications in 2 weeks. Do not apply in heat of day when leaf temp above 90 F. |
| | tomato pinworm | spinosad 0.5% | 4 Tbsp | 1 | Maximum of 6 applications per season; wait 4 days before reapplying. |
| | | bifenthrin 0.3% & zeta-cypermethrin 0.075% L | RTS | 1 | Wait at least 7 days between each application. |
| TURNIPS | aphid | malathion 50% L (Bonide) | 3 tsp | 3 | On foliage as needed. Wait at least 7 days between each application. |
| | caterpillars | Bacillus thuringiensis subsp. kurstaki | As recommended on the label. | 0 | Begin treatment when damage is first found and repeat weekly until harvest. |
| | flea beetles, harlequin bug | carbaryl 5 D | Apply according to label. | 7 (roots) 14 (tops) | See label for application restrictions. Maximum applications per season are not to exceed 4. |
| WATERMELON | aphid | bifenthrin 0.3% & zeta-cypermethrin 0.075% L | RTS | 3 | Wait at least 7 days between each application. |
| | | insecticide soap (potassium salts of fatty acids) 49.52% L | 5 Tbsp | 0 | For suppression. Repeat applications may be needed. Repeat at weekly to biweekly intervals up to 3 times. Do not make more than 3 sequential applications over a 2-week period. Do not apply during heat of day or when temps exceed 90 F. |
| | cucumber beetles | carbaryl 22.5% L | 3 Tbsp | 3 | Apply late in the day to minimize killing pollinating insects. Repeat applications as necessary up to 6 times, but not more often than once every 7 days. |
| | | 5D | Apply according to label. | 3 | |
| | permethrin 2.5% L | As recommended on the label. | 0 | Do not apply formulation more than 8 times per year. | |
| rindworms | See pickleworms on cantaloupes, but check label to ensure watermelon is listed. | | | | |
| spider mite | insecticide soap (potassium salts of fatty acids) 49.52% L | 5 Tbsp | 0 | No more than 3 applications in 2 weeks. Do not apply in heat of day when leaf temp above 90 F. | |

| VEGETABLE/INSECT | INSECTICIDE & FORMULATION L=Liquid, D=Dust, G=Granular | AMOUNT OF FORMULATION PER GALLON OF SPRAY (or as otherwise noted)* | MIN. INTERVAL (DAYS) BETWEEN LAST APPLICATION AND HARVEST | REMARKS AND PRECAUTIONS |
|-------------------------------|--|---|---|--|
| WATERMELON (cont'd) thrips | spinosad 0.5% | 4 Tbsp | 3 | Maximum of 6 applications per season; wait 5 days before reapplying. |

* Rates vary according to manufacturer; read the label to determine the correct rate for the product chosen.

Listed below are some of the products used to give rate recommendations in the previous tables. These are suggested products, other products do exist. If you are unable to find the product listed but can find the active ingredient and formulation, always check the label on the pesticide container to ensure the formulation chosen can be used on the pest or site needed. As always, follow the label directions when applying pesticides.

| Active Ingredient | Trade Name and Web Site |
|---|---|
| <p><i>Bacillus thuringiensis</i> subspecies <i>kurstaki</i> various strains, also referred to as Bt</p> | <p>Not all Bt products are labeled for all pests in all crops in which Bt is listed in this publication. Check individual label before purchasing to ensure pests and crops are listed.</p> <p>Bonide Thuricide http://www.bonide.com/assets/Products/Labels/l802.pdf</p> <p>Safer Brand Caterpillar Killer for Trees, Shrubs and Vegetables Concentrate http://images.saferbrand.com/is/content/woodstream/safer/us/content/pdf/5160gal%2Dsafer%2Dbrand%2Dcaterpillar%2Dkiller%2D1%2Dgallon%2Dconcentrate%2Dinstructions.pdf</p> <p>Safer Brand Caterpillar Killer for Trees, Shrubs and Vegetables Concentrate II http://www.kellysolutions.com/erenewals/documentssubmit/KellyData/OK/pesticide/Product%20Label/42697/70051%2D106%2D42697/70051%2D106%2D42697%5FSafer%5FBrand%5FCaterpillar%5FKiller%5Ffor%5FTrees%5FShrubs%5F%5F%5FVegetables%5FConcentrate%5FII%5F2%5F19%5F2014%5F9%5F45%5F22%5FAM%2DEpdf</p> <p>Safer Brand Garden Dust http://www.saferbrand.com/safer-brand-garden-dust-with-bt-8-oz-5162</p> <p>ferti-lome Dipel Dust http://www.fertilome.com/ProductFiles/10586_FL_11b%202-18-15.pdf</p> |
| <p>bifenthrin 0.3% & zeta-cypermethrin 0.075% L RTS</p> | <p>Ortho Bug-B-Gon Insect Killer for Lawns & Gardens Ready-to-Spray₁ http://www.kellysolutions.com/erenewals/documentssubmit/KellyData/OK/pesticide/Product%20Label/239/279%2D9535%2D239/279%2D9535%2D239%5FOrtho%5FBug%5FB%5FGon%5FInsect%5FKiller%5Ffor%5FLawns%5F%5F%5FGardens%5F%5F%5FRTS%5F3%5F27%5F2012%5F3%5F34%5F16%5FPM%2Epdf</p> |
| <p>bifenthrin 0.1% G</p> | <p>Hi-Yield Vegetable & Ornamental Insect Control Granules http://www.fertilome.com/ProductFiles/32327%20Veg%20Orn%20Insect%20Control%20Approved%2007-06-11.pdf</p> |

| Active Ingredient | Trade Name & Web Site |
|---------------------------------|---|
| bifenthrin 0.115% G | Bonide Eight Insect Control Flower & Vegetable Above & Below Soil Insect Granules, http://www.kellysolutions.com/erenewals/documentsubmit/KellyData/OK/pesticide/Product%20Label/4/53883-194-4/53883-194-4_Bonide_Eight_Insect_Control_Flower_Vegetable_Above_Below_Soil_Insect_Granules_2_8_2013_1_46_24_PM.pdf |
| carbaryl 22.5% L | *GardenTech Sevin Concentrate Bug Killer https://www.kellysolutions.com/ok/showproductinfo.asp?Product_Name=GardenTech+Sevin+Concentrate+Bug+Killer&EPA_Id=264%2D334%2D71004 *Check label closely to ensure active ingredient is carbaryl. GardenTech Sevin Concentrate Bug Killer also sold with zeta-cypermethrin as the active ingredient |
| carbaryl 5% D | GardenTech Sevin-5 Ready-To-Use 5% Dust Bug Killer http://www.gardentech.com |
| cyfluthrin 0.75% L | BioAdvanced Vegetable & Garden Insect Spray, Concentrate http://www.bioadvanced.com |
| cyfluthrin 0.75% L (RTS) | BioAdvanced Vegetable & Garden Insect Spray, Ready-to-spray (hose end sprayer) http://www.bioadvanced.com |
| esfenvalerate 0.425% L | Monterey_Bug_Buster_II http://216.119.118.152/documents/public/products/BugBusterII-2column(01)-Bilingual.pdf |
| gamma-cyhalothrin 0.08% | Spectracide Triazicide Insect Killer for Lawns & Landscapes, Concentrate http://www.spectracide.com/Products-and-Solutions/Outdoor-Insect-Killer.aspx |
| malathion 50% L | Bonide Malathion Insect Control Concentrate http://www.bonide.com/ |
| malathion 50% L | Spectracide Malathion Insect Spray Concentrate http://www.spectracide.com/Custom-Help/Labels-and-MSDS.aspx |
| permethrin 2.5% L | Bonide Eight Insect Control Vegetable, Fruit and Flower Concentrate http://www.bonideproducts.com |
| potassium salts of fatty acids_ | Safer Brand Insect Killing Soap Concentrate II http://www.saferbrand.com |
| spinosad 0.5% L | Natural Guard Spinosad Bagworm, Tent Caterpillar and Chewing Insect Control http://www.fertilome.com/ProductFiles/40690%20Spinosad%20oz.pdf Monterey Garden Insect Spray http://216.119.118.152/documents/public/products/MontereyGardenInsectSpray-2-column-(08)-0111-Bilingual.pdf |
| spinosad 0.015% | Certis Firefighter Fire Ant Bait https://www.certisusa.com |

Many of the products previously labeled as Bayer Advanced were rebranded as BioAdvanced Science-Based Solutions.

Ways to Minimize Pesticide Use in Gardens

Prevent Pest Problems

Choose the proper site and plants.

- Avoid planting your vegetable garden in ground that was in sod within two to three years. Soil insects are more likely to be numerous in this situation.
- Dig or plow the garden in the fall and again in the spring, at least three weeks before planting, to eliminate weeds supporting soil pests and to expose many pests to drying, cold weather and predators.
- Select resistant varieties when possible.
- Diversify plantings so plants are less visible to pests and natural enemies are better retained.
- Rotate crops to new locations in the garden to aid in reducing insects.

Encourage healthy growth of plants because stressed plants are often more susceptible to pests.

- Water plants in the morning to allow foliage to dry (furrow or drip irrigation is preferable).
- Space plants properly because overcrowding of plants can cause water, nutrient and light stress and “under crowding” can lead to weed problems.
- Control weeds constantly because destruction of a heavy weed stand can cause insect pests to migrate to the crop.
- Mulching is a good way to keep the weeds down in the garden, and it has many other benefits as well.
- Fertilize and adjust pH according to soil test results.
- Planting seeds too deep can cause them to rot before germinating or cracking through the soil.

Inspect regularly

- Inspect plants regularly for pests, pest damage, natural enemies, and conditions that lead to pest problems.
- Friend or foe? You should know! It is important to be able to distinguish pests from their natural enemies (other organisms that kill pests such as syrphid flies, lacewing larvae, parasitic wasps, lady bird beetles, insect-killing nematodes, pathogenic fungi, predatory mites, etc.).
- Early detection of pests can:
 - 1) reduce the spread of the pest,
 - 2) reduce the amount of pesticide used and therefore the cost of control, and
 - 3) allow for use of natural enemies or slow-acting, less toxic pesticides when there is not an imminent threat of damage.

Use alternative control methods

- Handpick pests when the pests are readily seen (Colorado potato beetles).
- Use water to force aphids and others small sucking insects from plants.
- Use physical barriers. Transplants such as tomato, pepper and eggplant can be wrapped with a 4-by-4-inch strip of aluminum foil to prevent cutworm damage and contact with the soilborne southern blight organism. Use 6-inch copper sheeting placed 2 inches into ground to block slug invasions.
- Repel insect vectors in tomatoes and cucurbits. Aluminum foil or plastic painted with a chrome-colored paint may repel thrips and aphids.
- Pick vegetables before they are overripe and are more attractive to certain insect pests.
- Encourage the conservation of natural enemies by reducing the amount of pesticide applied.
- Plant flowering plants, such as clovers and Queen Anne’s lace, to provide a food source (nectar and pollen) for natural enemies and enhance their control of pests.
- Use pesticides such as microbials (*Bacillus thuringiensis*), botanical insecticides (such as pyrethrum), and insecticidal soaps because they have less nontarget effects.

Pictorial Key of Common Adult Insects on Vegetables

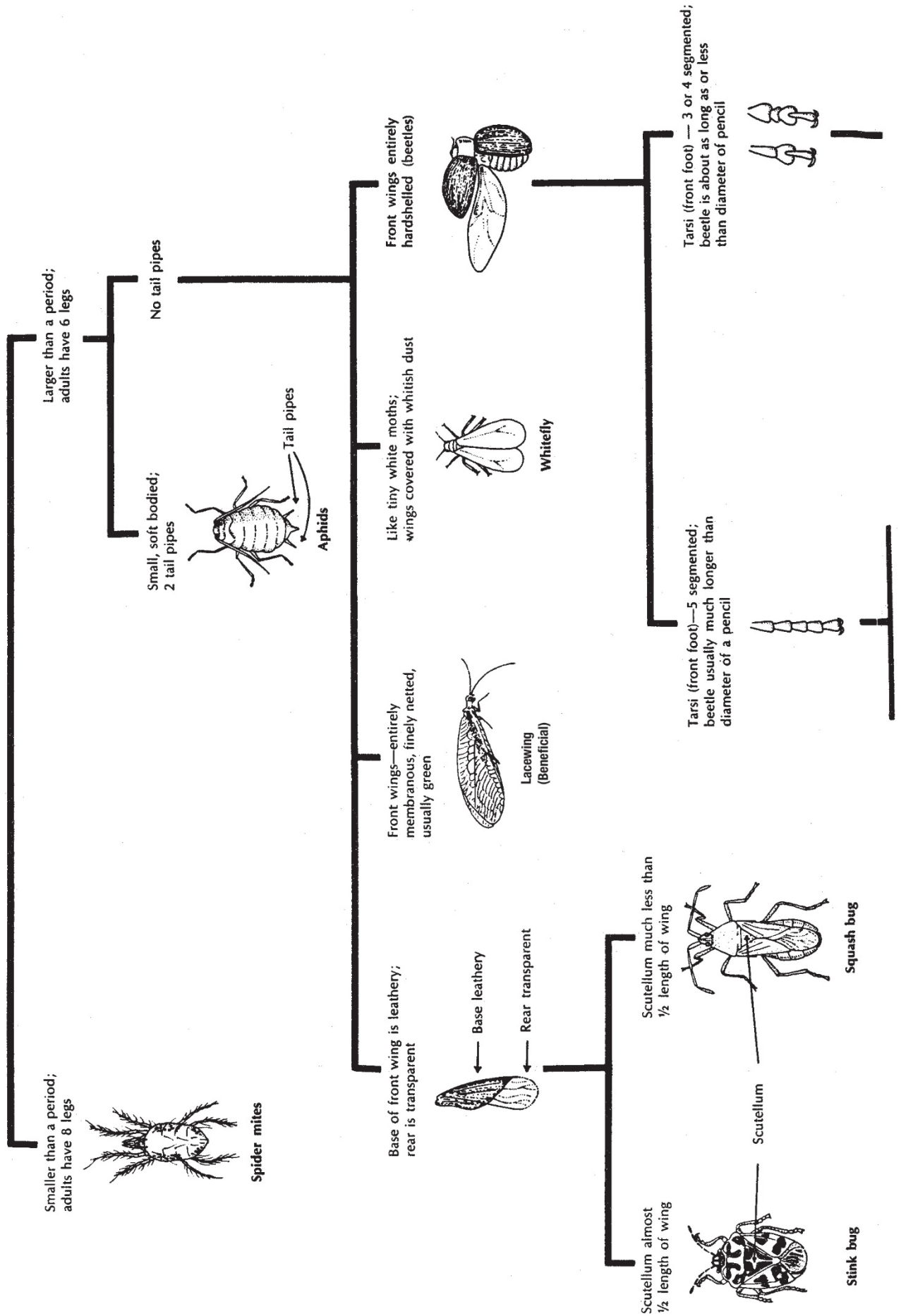

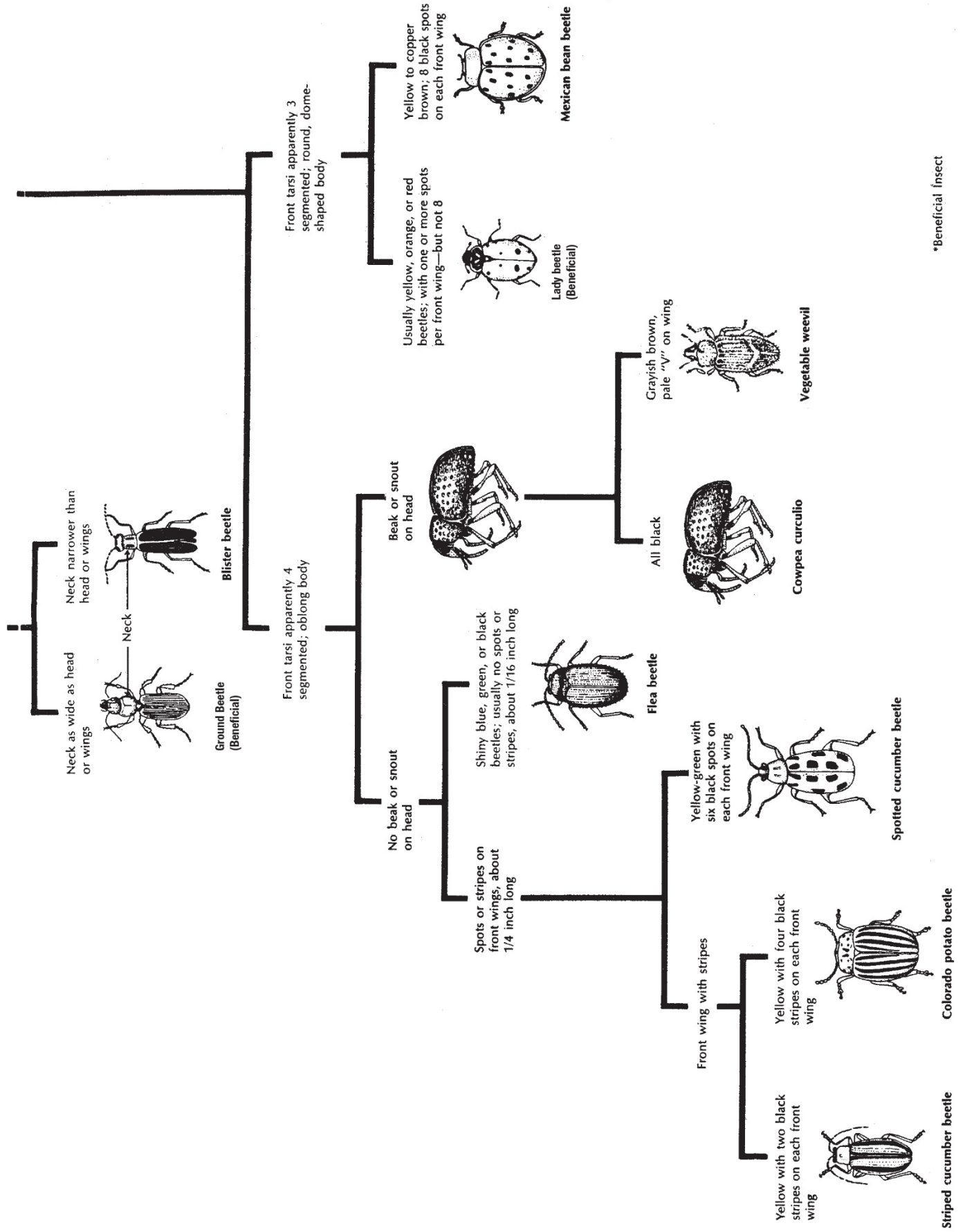

*Beneficial insect

Pictorial Key to Common Immature Insect Pests on Vegetables

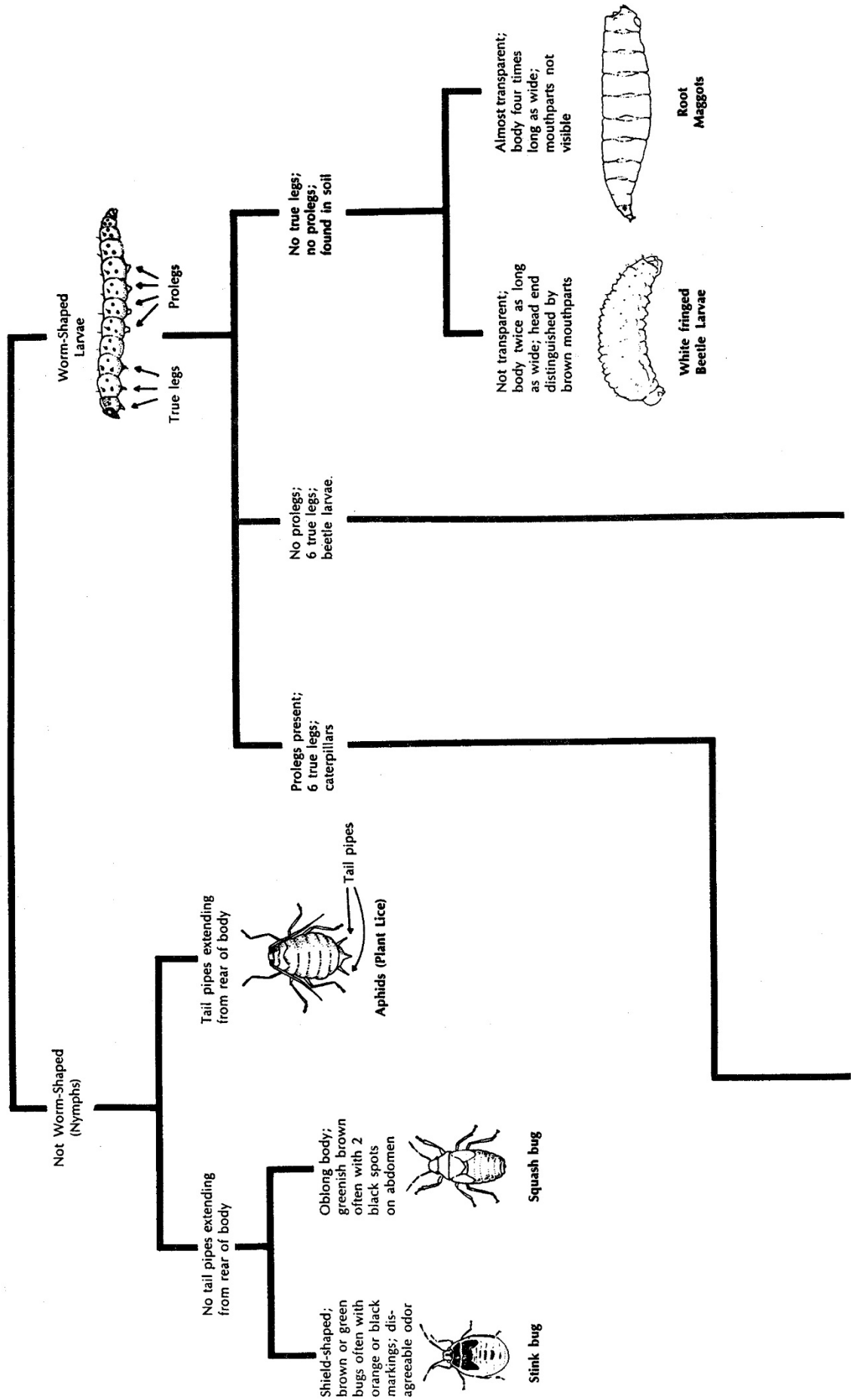

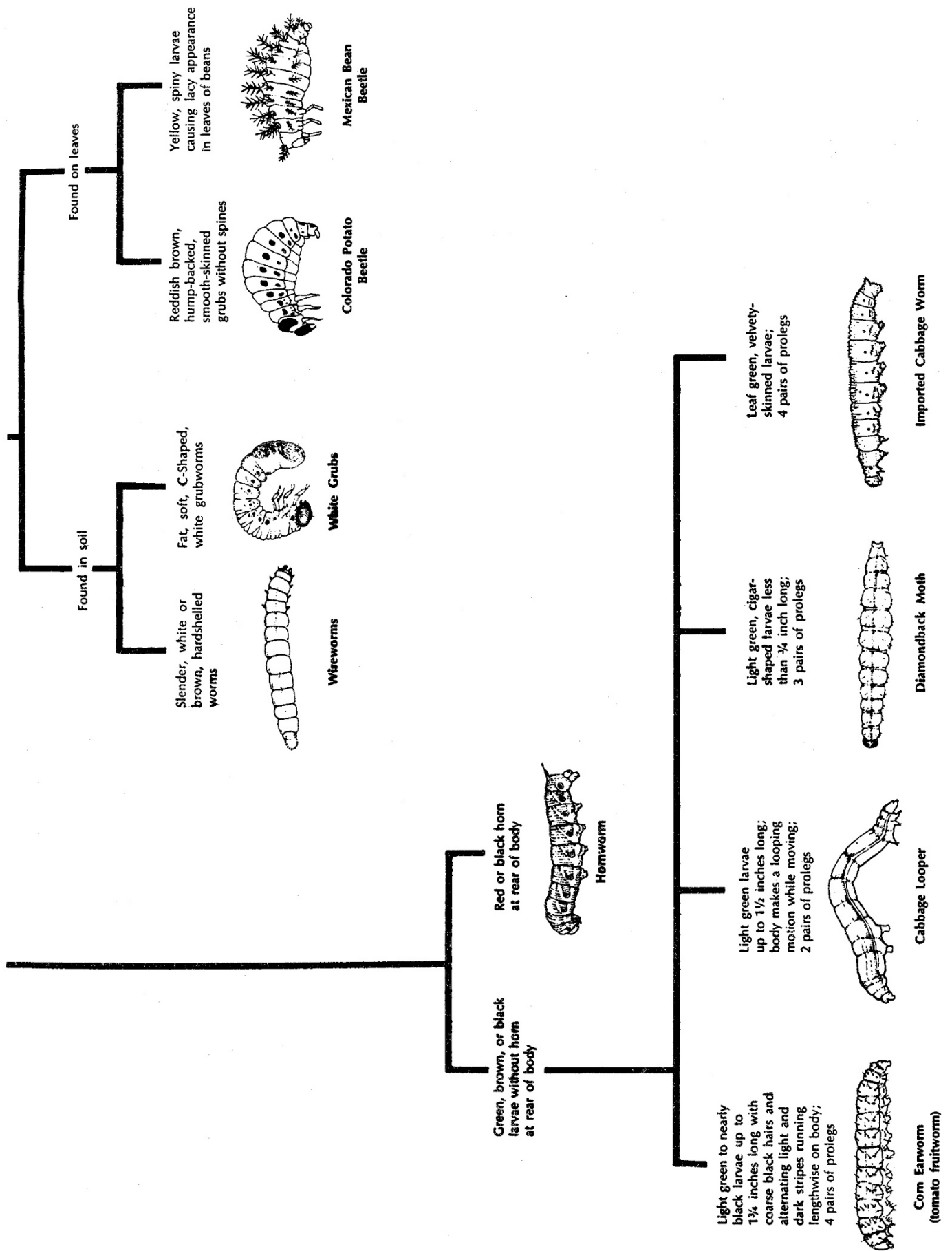

PRECAUTIONARY STATEMENT

To protect people and the environment, pesticides should be used safely. This is everyone's responsibility, especially the user. Read and follow label directions carefully before you buy, mix, apply, store, or dispose of a pesticide. According to laws regulating pesticides, they must be used only as directed by the label and registered for use in your state.

DISCLAIMER STATEMENT

This publication contains pesticide recommendations that are subject to change at any time. The recommendations in this publication are provided only as a guide. It is always the pesticide applicator's responsibility, by law, to read and follow all current label directions for the specific pesticide being used. The label takes precedence over the recommendations found in this publication. Use of trade or brand names in this publication is for clarity and information; it does not imply approval of the product to the exclusion of others which may be of similar, suitable composition, nor does it guarantee or warrant the standard of the product. The author(s), The University of Tennessee Institute of Agriculture and the University of Tennessee Extension assume no liability resulting from the use of these recommendations.



UTIA.TENNESSEE.EDU

PB 595(Rev) 07/20 20-0259

Programs in agriculture and natural resources, 4-H youth development, family and consumer sciences, and resource development.
University of Tennessee Institute of Agriculture, U.S. Department of Agriculture and county governments cooperating.
UT Extension provides equal opportunities in programs and employment.