



**BOSCH**



**Register** your  
new device on  
MyBosch now and  
get free benefits:  
**[bosch-home.com/  
welcome](https://bosch-home.com/welcome)**







# Gas hob

**PPH6S6F20I**

Instruction manual



# Table of contents

 Intended use . . . . .	3
 Important safety information . . . . .	4
 Causes of damage . . . . .	5
 Environmental protection . . . . .	5
Saving energy with the gas hob . . . . .	5
Environmentally friendly disposal . . . . .	5
 Getting to know your appliance . . . . .	6
The hob . . . . .	6
Individual parts of the burners . . . . .	6
Control knob for hotplates . . . . .	6
Suitable cooking vessels . . . . .	6
Precautions for use . . . . .	7
 Accessories . . . . .	7
Special accessories . . . . .	7
 Operating the appliance . . . . .	8
Switching on automatically . . . . .	8
Switching on manually . . . . .	8
Thermoelectric flame monitoring . . . . .	8
Switching off . . . . .	8
 Cleaning . . . . .	8
Cleaning . . . . .	8
Burnt-on dirt . . . . .	9
Do not use these cleaning agents . . . . .	9
Using cleaning gel . . . . .	9
 Trouble shooting . . . . .	10
 Customer service . . . . .	11

Additional information on products, accessories, replacement parts and services can be found at [www.bosch-home.com](http://www.bosch-home.com)

## Intended use

Read these instructions carefully. Only then will you be able to operate your appliance safely and correctly. Retain the instruction manual and assembly instructions for future use or for subsequent owners.

**The manufacturer is exempt from all responsibility if the requirements of this manual are not complied with.**

This appliance must be installed according to the installation instructions included.

Check the appliance for damage after unpacking it. Do not connect the appliance if it has been damaged in transport.

Only allow a licensed professional to connect the appliance. Damage caused by incorrect connection is not covered under warranty. Call the after-sales service if you want to convert your appliance to a different type of gas.

This appliance is intended for domestic use and the household environment only. This appliance must only be used to prepare food and drinks and must never be used as a heater. Do not leave the appliance unattended during operation. Only use the appliance indoors.

This appliance cannot be installed on yachts or in caravans.

This appliance is intended for use up to a maximum height of 2000 metres above sea level.

This appliance is not intended for operation with an external clock timer or a remote control.

**All operations relating to installation, connection, regulation and conversion to other gas types must be performed by an authorised technician, respecting all applicable regulations, standards and the specifications of the local gas and electricity suppliers. Special attention shall be paid to ventilation regulations.**

Do not use inappropriate child safety shields or hob guards. These can cause accidents.

This appliance may be used by children over the age of 8 years old and by persons with reduced physical, sensory or mental capabilities or by persons with a lack of experience or knowledge if they are supervised or are instructed by a person responsible for their safety how to use the appliance safely and have understood the associated hazards.

Children must not play with, on, or around the appliance. Children must not clean the appliance or carry out general maintenance unless they are at least 15 years old and are being supervised.

Keep children below the age of 8 years old at a safe distance from the appliance and power cable.

Close the safety valve on the gas supply line if the cooker will not be used for a prolonged period.

## Important safety information

### **Warning – WHAT TO DO IF YOU SMELL GAS!**

Escaping gas may cause an explosion.

#### **If you smell gas or notice any faults in the gas installation:**

- Immediately shut off the gas supply or close the gas cylinder valve.
- Immediately extinguish all naked flames and cigarettes.
- Do not use any light or appliance switches and do not pull any plugs out of sockets. Do not use any telephones or mobile phones within the building.
- Open windows and ventilate the room.
- Call the after-sales service or the gas supplier.

### **Warning – Risk of asphyxiation!**

The use of a gas cooker leads to a build-up of heat, moisture and products of combustion in the room where the appliance is installed. Ensure that the installation room is well ventilated. The natural ventilation openings must be kept open or a mechanical ventilation device must be provided (e.g. an extractor hood). Intensive and persistent use of the appliance may mean that it is necessary to have additional ventilation (e.g. opening a window), or more effective ventilation (e.g. operating the existing mechanical ventilation device at a higher setting).

### **Warning**

#### **Risk of fire!**

- Hot oil and fat can ignite very quickly. Never leave hot fat or oil unattended. Never use water to put out burning oil or fat. Switch off the hotplate. Extinguish flames carefully using a lid, fire blanket or something similar.
- The hotplates become very hot. Never place combustible items on the hob. Never place objects on the hob.
- The appliance becomes very hot and materials could catch fire. Make sure that you comply with the installing and connecting measurements and observe the minimum clearance above the appliance. Never store or use flammable objects (e.g. spray cans, cleaning agents) under the appliance or in its immediate vicinity. Never place flammable items on or in the appliance.
- When gas hotplates are in operation without any cookware placed on them, they can build up a lot of heat. The appliance and the extractor hood above it may become damaged or be set on fire. Grease residue in the filter of the extractor hood may ignite. Only operate the gas burners with cookware on them.

### **Warning**

#### **Risk of burns!**

- The accessible parts become very hot when in operation. Never touch hot parts. Keep children at a safe distance.
- Empty cookware becomes extremely hot when set on a gas hotplate that is in operation. Never heat up empty cookware.
- If the liquefied gas bottle is not upright, liquefied propane/butane can enter the appliance. Intense darting flames may therefore escape from the burners. Components may become damaged and start to leak over time so that gas escapes uncontrollably. Both can cause burns. Always use liquefied gas bottles in an upright position.

### **Warning**

#### **Risk of injury!**

- Incorrect repairs are dangerous. Repairs may only be carried out, and damaged power and gas lines replaced, by an after-sales engineer trained by us. If the appliance is faulty, unplug the mains plug or switch off the fuse in the fuse box. Shut off the gas supply. Contact the after-sales service.
- Faults or damage to the appliance are dangerous. Never switch on a faulty appliance. Unplug the appliance from the mains or switch off the circuit breaker in the fuse box. Shut off the gas supply. Contact the after-sales service.
- Unsuitable pan sizes, damaged or incorrectly positioned pans can cause serious injury. Observe the instructions which accompany the cookware.
- If a control knob is too stiff to turn or it is loose, it must not be used. Contact our after-sales service immediately to have the control knob repaired or replaced.

### **Warning**

#### **Risk of electric shock and serious injury!**

- The cable insulation on electrical appliances may melt when touching hot parts of the appliance. Never bring electrical appliance cables into contact with hot parts of the appliance.
- Do not use any high-pressure cleaners or steam cleaners, which can result in an electric shock.
- A defective appliance may cause electric shock. Never switch on a defective appliance. Unplug the appliance from the mains or switch off the circuit breaker in the fuse box. Contact the after-sales service.
- Incorrect repairs are dangerous. Repairs may only be carried out by one of our trained after-sales engineers. If the appliance is faulty, unplug the mains plug or switch off the fuse in the fuse box. Contact the after-sales service.

## Causes of damage

### Caution!

- **Heat damage to adjacent appliances or kitchen units:** Heat and moisture are produced if the appliance is operated over a prolonged period. Additional ventilation is required. Open windows and switch on an extraction hood which conducts into the open air.
- **Appliance damage caused by heat accumulation:** Do not heat roasting dishes, pans or grill stones on more than one burner at the same time.
- **Malfunction:** Always turn control knobs to the OFF position when the appliance is not in operation.

## Environmental protection

### Saving energy with the gas hob

- Always use a saucepan which is the correct size for your food. A larger, less full saucepan requires a lot of energy.
- Always place a suitable lid on the saucepan.
- The gas flame must always be in contact with the base of the saucepan.

### Environmentally friendly disposal

Remove the appliance from its packaging and dispose of the packaging in line with the relevant environmental regulations.

## Getting to know your appliance

In this chapter you will get to know your new appliance and find further information on the range of accessories.

### The hob

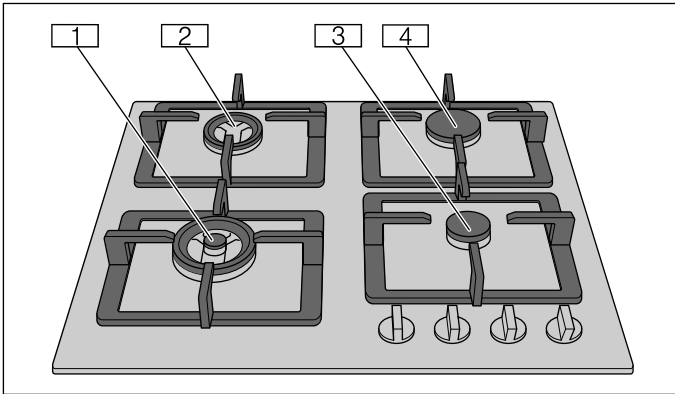

No.	Designation
1	Three-ring high output burner (4.2 kW)
2	Two-ring standard-output burner (2.0 kW)
3	Economy burner (1.0 kW)
4	Standard output burner (1.75 kW)

### Individual parts of the burners

Ensure that the individual parts of the burners are fitted in the correct position and are straight; otherwise, this may result in ignition problems or problems during operation. Fit the burner head and the burner ring in such a way that the latches on the lower section of the burner click into place in the corresponding slots. The alignment of the burner head and the burner ring is not important.

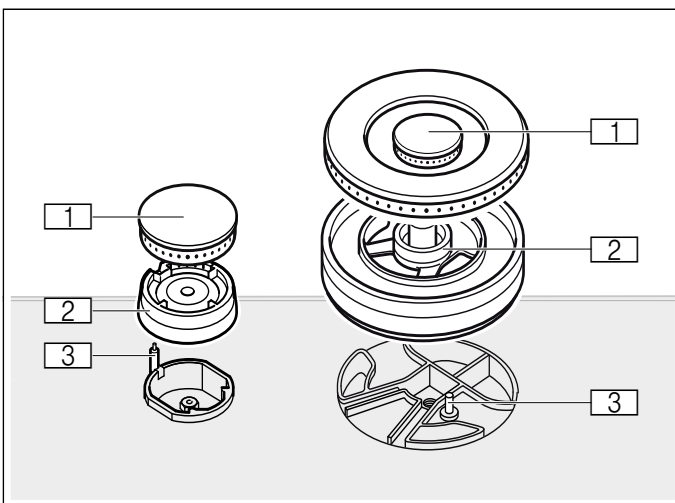

No.	Designation
1	Burner cap
2	Burner head
3	Ignition plug

### Control knob for hotplates

The control knobs for the gas burners are used to set the heat output of the gas burners.

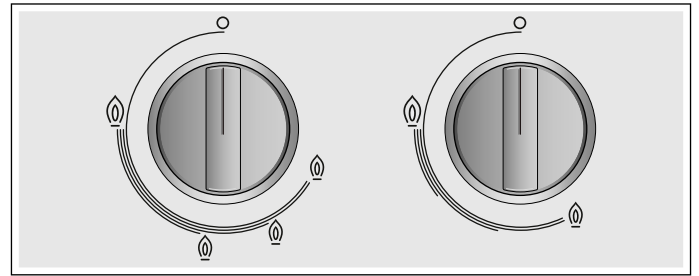

Setting	Meaning
○	Off
🔥	Large flame, highest power
🔥	Large flame, lowest power
🔥	Economy flame, highest power
🔥	Economy flame, lowest power

### Suitable cooking vessels

Burner	Minimum pan base diameter	Maximum pan base diameter
Economy burner	80 mm	160 mm
Three-ring high-output burner	220 mm	260 mm
Two-ring standard-output burner	140 mm	220 mm
Standard-output burner	120 mm	200 mm

## Precautions for use

The following advice is intended to help you save energy and prevent pan damage:

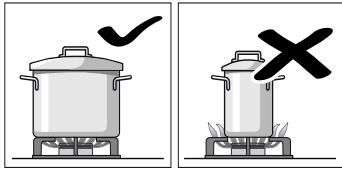

Use pans which are the right size for each burner. Do not use small pans on large burners. The flame must not touch the sides of the pan.

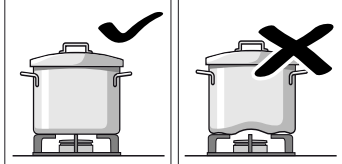

Do not use damaged pans, which do not sit evenly on the hob. Pans may tip over. Only use pans with a thick, flat base.

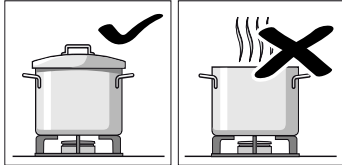

Do not cook without using a lid and make sure the lid is properly fitted. This wastes energy.

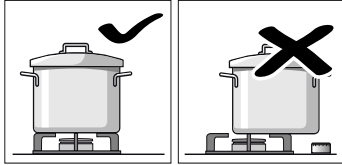

Always centre the pan over the burner, not to one side. Otherwise it could tip over. Do not place large pans on the burners near the control knobs. These may be damaged by the very high temperatures.

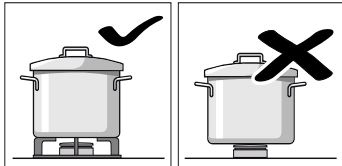

Place the pans on the pan supports, never directly on the burner. Make sure that the pan supports and burner caps are correctly positioned before using the appliance.

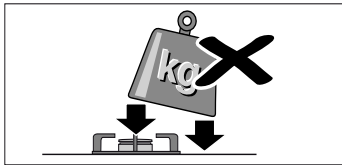

Pans should be placed on the hob carefully. Do not strike the hob and do not place excessive weight on it.

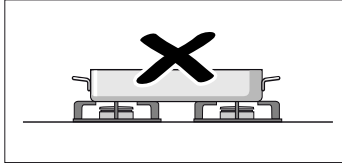

Never use two burners or heat sources to heat one single pan. Do not use grill pans, earthenware casserole dishes, etc. for a long period of time on maximum power.

## Accessories

### Special accessories

Accessory	Order number
Nozzle set for natural gas (NG)	10008364

## Operating the appliance

### Notes

- Only use the accessories specified. Do not line the cooktop (e.g. with aluminium foil).
- The burner and ignition plug must be clean and dry.
- Only light the hotplates if the pan supports and all burner parts are correctly fitted.
- When one burner is ignited, an ignition spark will also be generated at all the other burners.
- Do not touch the ignition plug while the gas appliance is being lit.
- It is important to keep the appliance clean. If the ignition plugs are dirty, this may cause ignition problems. Clean the ignition plugs regularly with a small, non-metallic brush. Take care to prevent the ignition plugs from suffering any heavy knocks.
- When the gas cooktop is switched on, the electronics open up the gas supply, which produces a short sound. This is normal.

### Switching on automatically

Your gas hob comes with ignition plugs for electrical ignition.

1. Place suitable cookware on the required burner.
2. Press the corresponding control knob in and turn it anti-clockwise to the required heat setting. The burner will ignite automatically.
3. Keep the control knob pressed in for a few seconds after ignition.

### Warning – Risk of deflagration!

If the burner does not ignite after 10 seconds, switch off the control knob and open the door or window in the room. Wait at least 1 minute before trying to ignite the burner again.

### Switching on manually

1. Press the chosen burner control knob and turn it anticlockwise to the required setting.
2. Use any type of lighter or flame (cigarette lighter, matches, etc.) and bring it close to the burner.

### Thermoelectric flame monitoring

For your safety, the hob is fitted with thermoelectric flame monitoring. This prevents the flow of gas if the burner accidentally goes out while it is in use (e.g. due to draughts).

If the burner accidentally goes out while it is in use, turn the control knob to position 0 and wait at least one minute before you ignite the burner again.

### Switching off

Turn the control knob you require clockwise to position 0 until the control knob locks in place.

## Cleaning

### Warning – Risk of burns!

The appliance becomes hot during operation. Allow the appliance to cool down before cleaning.

### Warning – Risk of electric shock!

Do not use high pressure washers or steam cleaners to clean the appliance.

### Cleaning

Clean the appliance after every use once it has cooled down. Remove spills immediately. Burnt in residues and milk spills may be difficult to remove.

Assemble the burner parts and pan supports after cleaning and drying them. Make sure all burner parts are properly fitted. Burner ring and burner cover must lock in place and lie evenly flat.

Part/surface	Recommended cleaning method
Stainless steel surfaces	<p>Clean with a soft cloth and some soapy water; polish dry with a soft cloth. Do not use too much water to avoid water entering the appliance.</p> <p><b>Caution!</b> <b>Damage to the seal</b> Do not clean the gap around the stainless steel surface with sharp objects. Only clean with a soft brush.</p> <p>To remove stubborn residues including discoloration and dried milk spills because of the heat, you can order a stainless-steel cleaner (order number 464524) from your specialist retailer or our after-sales service.</p>
Pan support	<p>Carefully take off pan supports for cleaning. Soak in soapy water. Clean with a brush and some detergent.</p> <p>Be careful when cleaning around the rubber rests to ensure they do not come loose.</p> <p>Rinse with clear water. Carefully dry pan support before assembly.</p> <p><b>Do not clean in a dishwasher!</b></p>
Control knobs	<p>Clean with a soft, moist cloth and some soapy water; do not use too much water.</p> <p><b>Caution!</b> <b>Damage to the appliance</b> Do not pull off the control knobs to clean them.</p>



Part/surface	Recommended cleaning method
Burner parts	Clean away food particles with a soft brush and rinse with clear water. Carefully dry burner parts before assembly. <b>Do not clean in a dishwasher!</b>
Ignition sparkers	If required, clean with a fine brush.

## Burnt-on dirt

For hard-to-remove, burnt-on dirt, you can order a cleaning gel from our online shop, from your specialist retailer or our after-sales service (item number 00311859). It is suitable for pan supports and the stainless-steel recess. If necessary, let the dirt soak overnight. Follow the instructions on the cleaning agent.

### Caution!

#### Damage to the surface

Do not use the cleaning gel on the burner parts.

## Do not use these cleaning agents

- Scouring or chemically aggressive cleaners
- Acidic cleaners (e.g. vinegar, citric acid, etc)
- Cleaners containing chlorine or with a high content of alcohol
- Oven cleaner
- Hard and scratchy sponges, brushes or scouring pads
- Thoroughly wash out new sponge cloths before using them.

## Using cleaning gel

1. Remove pan supports, burner caps and burner heads.
2. Apply cleaning gel.
3. Leave the cleaning gel on for a few minutes.
4. Use warm water and a soft sponge to clean the surface.
5. Wipe with a wet soft cloth.
6. Dry with a dry soft cloth.

## Trouble shooting

Fault	Possible cause	Solution
Malfunction of the general electrical system.	The household fuse has tripped.	Check the fuse box if the fuse has tripped.
The electric ignition does not work.	There may be food or cleaning products stuck between the ignition sparkers and the burners.	The space between the ignition sparker and the burner must be clean.
	The burners are wet.	Dry the burner caps carefully.
	The burner caps are not correctly positioned.	Check that the burner caps are correctly positioned.
	Power cut	Ignite the burner with a lighter or a match.
The burner flame is not uniform.	The burner components are not correctly positioned.	Ensure the components are correctly positioned.
	The grooves on the burner are dirty.	Clean the grooves on the burner.
The gas flow is not normal or there is no gas.	The gas supply is blocked via gas taps.	Open all gas taps.
	If the gas is supplied from a gas cylinder, check that this is not empty.	Change the gas cylinder.
The kitchen smells of gas.	There may be a leak in the gas cylinder coupling.	Check that the coupling is sound.
The burner goes off after ignition.	The control knob was not held down for long enough.	Once the burner is on, hold the control knob down a few seconds longer. Fully press control knob.
	The grooves on the burner are dirty.	Clean the grooves on the burner.

 **Customer service**

When contacting our Technical Assistance Service, please provide the product number (E-Nr.) and production number (FD) of the appliance. This information is given on the specifications plate located on the lower section of the hob and on the label in the user manual.

You can make a note of the numbers of your appliance and the telephone number of the after-sales service in the space below to save time should it be required.

<b>E no.</b>	<b>FD no.</b>
<b>After-sales service</b> 	

Please be aware that a visit by an after-sales engineer will be charged if a problem turns out to be the result of operator error, even during the warranty period.



## Thank you for buying a Bosch Home Appliance!

Register your new device on MyBosch now and profit directly from:

- **Expert tips & tricks for your appliance**
- **Warranty extension options**
- **Discounts for accessories & spare-parts**
- **Digital manual and all appliance data at hand**
- **Easy access to Bosch Home Appliances Service**

Free and easy registration – also on mobile phones:

**[www.bosch-home.com/welcome](http://www.bosch-home.com/welcome)**



## Looking for help? You 'll find it here.

Expert advice for your Bosch home appliances, need help with problems or a repair from Bosch experts.

Find out everything about the many ways Bosch can support you:

**[www.bosch-home.com/service](http://www.bosch-home.com/service)**

**Contact data of all countries are listed in the attached service directory.**

**Robert Bosch Hausgeräte GmbH**

Carl-Wery-Straße 34

81739 München

Germany

**[www.bosch-home.com](http://www.bosch-home.com)**



9001391163

990201